



CATÁLOGO DE PARTES



VICTORY
BLACKLINE

ZONTES 350R1



SISTEMA DE ENCENDIDO AUTOMÁTICO DE LUCES
Para mayor información del sistema consulte la página web
www.autecomobility.com
www.autecomobility.com



SISTEMA ANTIBLOQUEO DE FRENOS



LUCES DE CIRCULACIÓN DIURNA NO INCLUIDO

Para mayor información del sistema consulte la página web
www.autecomobility.com
www.autecomobility.com



www.autecomobility.com | contactanos@autecomobility.com
Línea gratuita nacional 018000 413 812

Advierta lo que le dicen las llantas mientras conduce:

- Si su respuesta a la dirección es lenta o si en las curvas y en el frenado la respuesta es pesada, es muy probable que sus llantas estén desinfladas.
- Vibración o tambaleo durante la conducción, puede significar que la presión en las llantas es mayor a la recomendada, o que ha ocurrido un daño en la llanta y la falla es inminente.
- La llanta puede vibrar a ciertas velocidades debido al desbalanceo, en este caso su desgaste será muy acelerado.

**RECUERDE SIEMPRE REVISAR LA PRESIÓN DE AIRE EN SUS LLANTAS
ANTES DE COMENZAR A RODAR**

PREFACIO

Es nuestro placer presentarles a ustedes el Catálogo de Partes.

Este Catálogo ha sido especialmente diseñado para ayudarle en la selección de las partes correctas con el fin de mantener el vehículo en las mejores condiciones.

Los repuestos originales están sujetos a un exigente estándar de control de calidad, por lo tanto es necesario que usted sólo use repuestos originales.

En nuestro constante esfuerzo para mejorar la eficiencia y desempeño de su vehículo, las especificaciones, diagramas y número de partes pueden cambiar sin previo aviso. Consecuentemente las descripciones de los repuestos en este Catálogo pueden no ser las finales y definitivas.

Las alteraciones y modificaciones que ocurren en la impresión de este Catálogo, serán informadas a nuestra red, a través de circulares de Servicio o en nuestra página web: www.auteco.com.co accediendo al link repuestos. Es requisito que usted actualice su Catálogo y haga las correcciones necesarias, una vez reciba dichas circulares. Lo anterior le asegurará un rápido y adecuado despacho de sus partes, pues las órdenes están siendo diligenciadas con las referencias más actualizadas.

En caso de necesitar asistencia técnica, comunicarse con el Distribuidor Autorizado o llamar al Departamento de Servicios Auteco.

REVISADO EN MARZO 2024



EL EQUIPO ORIGINAL
DE LAS MOTOCICLETAS



*Una garantía de respaldo,
calidad y experiencia.*

Mobil 1

CON EL RESPALDO



GRADO
SAE

10W-40

Full-Sintético

CUMPLE CON LAS
NORMATIVAS

JASO MA 2011

JASO MA2 2011

API SN

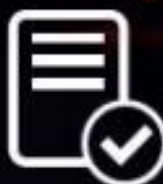

CÓDIGO SAP:

CAJA X 6

21008022

UNIDAD

21008023



PROPIEDADES & BENEFICIOS



- ▶ **Propiedades de fricción optimizadas**
Consistente potencia debido a menores pérdidas por fricción. Un balance global optimizado de desempeño del motor y de menor consumo de gasolina.
- ▶ **Excepcional protección contra el desgaste**
Ayuda a prolongar la vida del motor.
- ▶ **Excepcional estabilidad térmica y contra la oxidación**
Protección de película fluida en todas las temperaturas de operación que reduce al mínimo la formación de depósitos, sobre todo a las altas temperaturas de operación encontradas en los motores enfriados por aire.
- ▶ **Excepcionales propiedades a bajas temperaturas**
La lubricación efectiva a temperaturas ambientales bajas ayuda a facilitar el arranque, a brindar una rápida protección contra el desgaste y una menor carga sobre los sistemas de arranque.
- ▶ **Excelente capacidad detergente y dispersante**
Excepcional limpieza del motor y una operación suave y confiable.
- ▶ **Efectiva protección contra la herrumbre y la corrosión**
Una larga vida útil de los componentes críticos del tren de válvulas y de los cojinetes.

ACEITE ORIGINAL
PARA MOTOCICLETAS



VICTORY

BLACKLINE









Recomendado para la lubricación de motores de cuatro tiempos de motocicletas de **ALTO RENDIMIENTO**.

FIG. Nº	DESCRIPCIÓN	PAG. Nº
FIG. Nº1	VELOCIMETRO	1
FIG. Nº2	CUBIERTA INFERIOR VELOCIMETRO	1
FIG. Nº3	CUBIERTA FAROLA	2
FIG. Nº4	FAROLA	2
FIG. Nº5	SOPORTE SUPERIOR FAROLA	3
FIG. Nº6	CUBIERTA CABLEADO FAROLA	3
FIG. Nº7	SOPORTE FAROLA	4
FIG. Nº8	SOPORTES CUBIERTA	4
FIG. Nº9	TANQUE DE COMBUSTIBLE	5
FIG. Nº10	SOPORTE TANQUE DE COMBUSTIBLE	5
FIG. Nº11	SOPORTES	6
FIG. Nº12	CUBIERTA TANQUE IZQUIERDO	6
FIG. Nº13	CUBIERTA TANQUE DERECHA	7
FIG. Nº14	CUBIERTA CENTRAL TANQUE	7
FIG. Nº15	CUBIERTAS LATERALES	8
FIG. Nº16	CUBIERTAS LATERALES	9
FIG. Nº17	DIRECCIONALES DELANTERAS	10
FIG. Nº18	ENFOCADORES	10
FIG. Nº19	CAJA DISPOSITIVOS ELECTRICOS	11
FIG. Nº20	BATERIA	12
FIG. Nº21	SOPORTE BATERIA	12
FIG. Nº22	CUBIERTA IZQUIERDA SILLIN	13
FIG. Nº23	CUBIERTA DERECHA SILLIN	13
FIG. Nº24	CUBIERTAS LATERALES INTERIORES	14
FIG. Nº25	CUBIERTA INFERIOR SILLIN	14
FIG. Nº26	STOP TRASERO	15
FIG. Nº27	SOPORTE STOP TRASERO	15
FIG. Nº28	SOPORTE GUARDABARROS TRASERO	16
FIG. Nº29	SOPORTE GUARDABARROS TRASERO	16
FIG. Nº30	GUARDABARRO TRASERO	17
FIG. Nº31	SOPORTE DIRECCIONALES COMPLETO	17
FIG. Nº32	SOPORTE DIRECCIONALES TRASERAS	18
FIG. Nº33	RAMAL GUARDABARRO TRASERO	18
FIG. Nº34	SOPORTE PLACA	19
FIG. Nº35	PORTA PLACA	19
FIG. Nº36	SILLÍN	20
FIG. Nº37	MANUBRIO	21
FIG. Nº38	LEVA DE CLUTCH	22
FIG. Nº39	SOPORTE MANUBRIO	23
FIG. Nº40	LEVA DE FRENO	24
FIG. Nº41	SOPORTE MODULO ABS	25
FIG. Nº42	TORNILLERIA	25
FIG. Nº43	SOPORTE TUBOS SUSPENSION DELANTERA	26
FIG. Nº44	CUNAS DIRECCIÓN	26
FIG. Nº45	HORQUILLA DIRECCIÓN	27
FIG. Nº46	BARRAS DE SUSPENSION DELANTERA	27
FIG. Nº47	RUEDA DELANTERA	28
FIG. Nº48	RUEDA FÓNICA, RUEDA DELANTERA	28
FIG. Nº49	BRAZO OSCILANTE	29

FIG. Nº	DESCRIPCIÓN	PAG. Nº
FIG. Nº50	DESLIZADOR CADENA	30
FIG. Nº51	GUARDABARRO TRASERO INFERIOR INTERNO	30
FIG. Nº52	AMORTIGUADOR TRASERO	31
FIG. Nº53	COMPLEMENTO TIJERA	31
FIG. Nº54	PROTECTOR SPROCKET	32
FIG. Nº55	CADENA	32
FIG. Nº56	SOPORTE DENTADO BRAZO OSCILANTE	33
FIG. Nº57	SOPORTE FRENO TRASERO	33
FIG. Nº58	EJE RUEDA TRASERA	34
FIG. Nº59	RUEDA TRASERA	34
FIG. Nº60	PARTES CHASIS	35
FIG. Nº61	PARTES ELECTRICAS	36
FIG. Nº62	PITO Y SEGURO SILLIN	37
FIG. Nº63	REGULADOR	37
FIG. Nº64	CONTROLADOR ENCENDIDO Y CONTROLES	38
FIG. Nº65	SENSOR SOPORTE LATERAL	38
FIG. Nº66	SOPORTE MOTOR	39
FIG. Nº67	SOPORTE LATERAL	39
FIG. Nº68	CAJA FILTRO DE AIRE	40
FIG. Nº69	CUERPO DE INYECCIÓN	40
FIG. Nº70	SOPORTE INYECTOR	41
FIG. Nº71	MOTOR	41
FIG. Nº72	TAPA TRASERA IZQUIERDA MOTOR	42
FIG. Nº73	SILENCIADOR	42
FIG. Nº74	PARTE TRASERA SILENCIADOR	43
FIG. Nº75	SOPORTE REPOSAPIES IZQUIERDO	43
FIG. Nº76	REPOSAPIE DELANTERO IZQUIERDO	44
FIG. Nº77	SOPORTE DE BLOQUEO DE FRENO DE DISCO	44
FIG. Nº78	MUÑON PEDAL DE CAMBIOS	45
FIG. Nº79	PEDAL DE CAMBIOS	45
FIG. Nº80	SOPORTE REPOSAPIES DERECHO	46
FIG. Nº81	TORNILLO PEDAL FRENO	46
FIG. Nº82	PEDAL DE FRENO	47
FIG. Nº83	CUBIERTA BOMBA DE FRENO TRASERO	48
FIG. Nº84	PLATINA MOFLE	48
FIG. Nº85	BASE REPOSAPIE	49
FIG. Nº86	RADIADOR	49
FIG. Nº87	TAPA RADIADOR	50
FIG. Nº88	TANQUE RESERVORIO	50
FIG. Nº89	TERMOSTATO Y MANGUERAS	51
FIG. Nº90	RADIADOR DE ACEITE	52
FIG. Nº91	TUBO ENTRADA – SALIDA DE ACEITE	52
FIG. Nº92	CULATA	53
FIG. Nº93	CULATA	54
FIG. Nº94	CULATA	54
FIG. Nº95	CULATA	55
FIG. Nº96	TAPA CULATA	55
FIG. Nº97	KIT CILINDRO	56
FIG. Nº98	CILINDRO COMPLETO	56

INDICE GRAFICOS

INDICE GRAFICOS					
 <p style="text-align: center; font-size: small;">COMPONENTES</p>	 <p style="text-align: center; font-size: small;">COMPONENTES</p>	 <p style="text-align: center; font-size: small;">COMPONENTES</p>			
FIGURA N° 1: VELOCIMETRO	PÁG.N° 1	FIGURA N° 2: CUBIERTA INFERIOR VELOCIMERO	PÁG.N° 1	FIGURA N° 3: CUBIERTA FAROLA	PÁG.N° 2
 <p style="text-align: center; font-size: small;">COMPONENTES</p>	 <p style="text-align: center; font-size: small;">COMPONENTES</p>	 <p style="text-align: center; font-size: small;">COMPONENTES</p>			
FIGURA N° 4: FAROLA	PÁG.N° 2	FIGURA N° 5: SOPORTE SUPERIOR FAROLA	PÁG.N° 3	FIGURA N° 6: CUBIERTA CABLEADO FAROLA	PÁG.N° 3

INDICE GRAFICOS



FIGURA N° 7: SOPORTE FAROLA

PÁG.N° 4



FIGURA N° 8: SOPORTES CUBIERTA

PÁG.N° 4

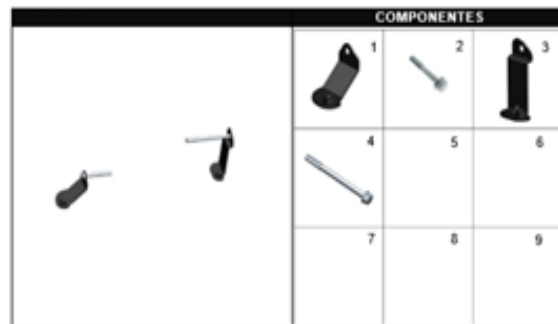

FIGURA N° 9: TANQUE DE COMBUSTIBLE

PÁG.N° 5



FIGURA N° 10: SOPORTE TANQUE DE COMBUSTIBLE

PÁG.N° 5



FIGURA N° 11: SOPORTES





PÁG.N° 6





FIGURA N° 12: CUBIERTA TANQUE IZQUIERDO

PÁG.N° 6

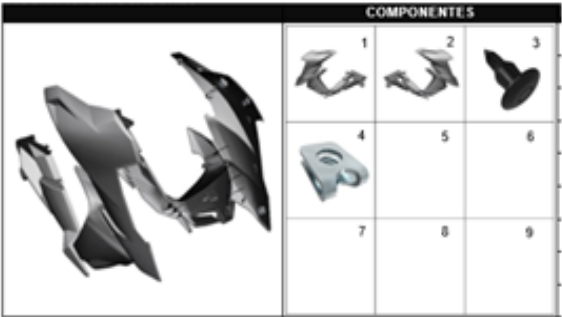
INDICE GRAFICOS

		
<p>FIGURA N° 13: CUBIERTA TANQUE DERECHA PÁG.N°7</p>	<p>FIGURA N° 14: CUBIERTA CENTRAL TANQUE PÁG.N°7</p>	<p>FIGURA N° 15: CUBIERTAS LATERALES PÁG.N°8</p>
		
<p>FIGURA N° 16: CUBIERTAS LATERALES PÁG.N°9</p>	<p>FIGURA N° 17: DIRECCIONALES DELANTERAS PÁG.N° 10</p>	<p>FIGURA N° 18: ENFOCADORES PÁG.N°10</p>

INDICE GRAFICOS

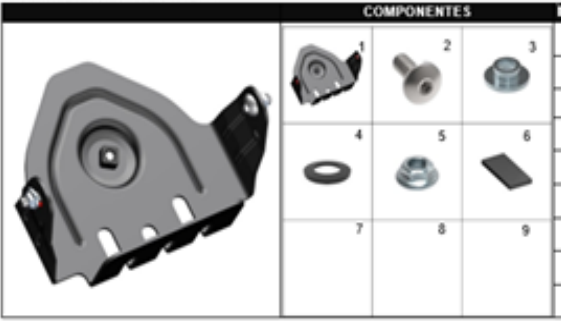
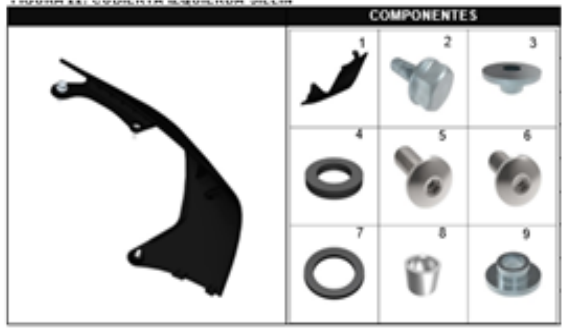
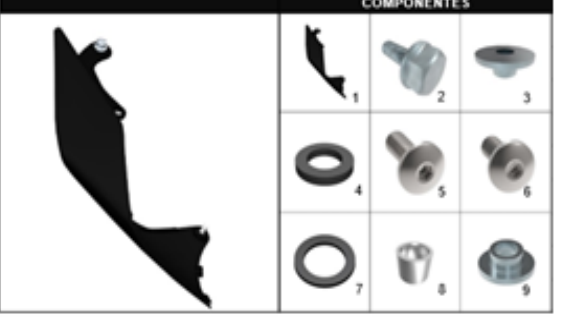
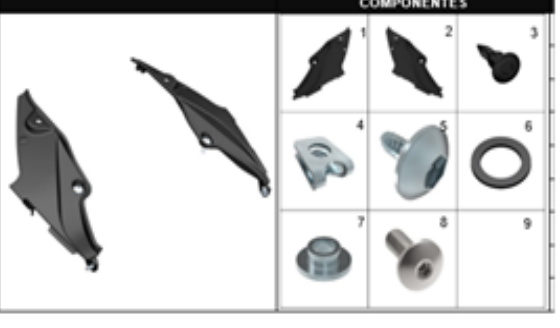
		
<p>FIGURA N° 19: CAJA DISPOSITIVOS ELECTRICOS PÁ G.N° 11</p>	<p>FIGURA N° 20: BATERÍA PÁ G.N° 12</p>	<p>FIGURA N° 21: SOPORTE BATERÍA PÁ G.N° 12</p>
		
<p>FIGURA N° 22: CUBIERTA IZQUIERDA SILLÍN PÁ G.N° 13</p>	<p>FIGURA N° 23: CUBIERTA DERECHA SILLÍN PÁ G.N° 13</p>	<p>FIGURA N° 24: CUBIERTAS LATERALES INTERIORES PÁ G.N° 14</p>

INDICE GRAFICOS



FIGURA N° 25: CUBIERTA INFERIOR SILLÍN

PÁ G.N° 14

FIGURA N° 26: STOP TRA SERO

PÁ G.N° 15

FIGURA N° 27: SOPORTE STOP TRA SERO

PÁ G.N° 15



FIGURA N° 28: SOPORTE GUARDA BARRA TRA SERO

PÁ G.N° 16

FIGURA N° 29: SOPORTE GUARDA BARRA TRA SERO

PÁ G.N° 16

FIGURA N° 30: GUARDA BARRA TRA SERO

PÁ G.N° 17

INDICE GRAFICOS



FIGURA N° 31: SOPORTE DIRECCIONALES COMPLETO

PÁ G.N°17



FIGURA N° 32: SOPORTE DIRECCIONALES TRASERAS

PÁ G.N°18

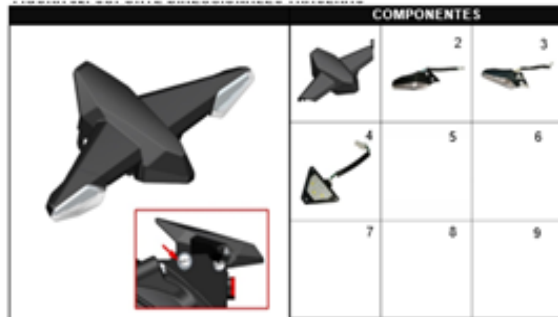

FIGURA N° 33: RAMAL GUARDA BARRO TRASERO

PÁ G.N°18

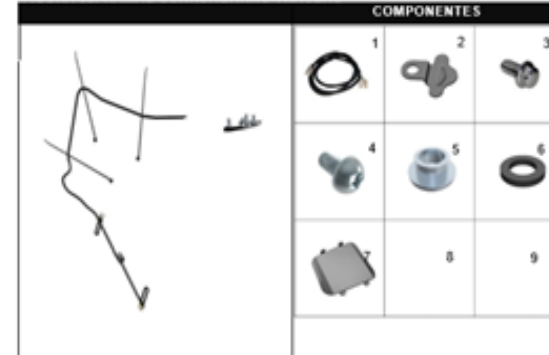

FIGURA N° 34: SOPORTE PLACA

PÁ G.N°19



FIGURA N° 35: PORTA PLACA

PÁ G.N°19



FIGURA N° 36: SILLÍN

PÁ G.N°20

INDICE GRAFICOS

	<table border="1" style="width: 100%; border-collapse: collapse;"> <thead> <tr> <th colspan="3" style="text-align: center;">COMPONENTES</th> </tr> </thead> <tbody> <tr><td style="text-align: center;">1</td><td style="text-align: center;">2</td><td style="text-align: center;">3</td></tr> <tr><td style="text-align: center;">4</td><td style="text-align: center;">5</td><td style="text-align: center;">6</td></tr> <tr><td style="text-align: center;">7</td><td style="text-align: center;">8</td><td style="text-align: center;">9</td></tr> </tbody> </table>	COMPONENTES			1	2	3	4	5	6	7	8	9		<table border="1" style="width: 100%; border-collapse: collapse;"> <thead> <tr> <th colspan="3" style="text-align: center;">COMPONENTES</th> </tr> </thead> <tbody> <tr><td style="text-align: center;">1</td><td style="text-align: center;">2</td><td style="text-align: center;">3</td></tr> <tr><td style="text-align: center;">4</td><td style="text-align: center;">5</td><td style="text-align: center;">6</td></tr> <tr><td style="text-align: center;">7</td><td style="text-align: center;">8</td><td style="text-align: center;">9</td></tr> </tbody> </table>	COMPONENTES			1	2	3	4	5	6	7	8	9
COMPONENTES																											
1	2	3																									
4	5	6																									
7	8	9																									
COMPONENTES																											
1	2	3																									
4	5	6																									
7	8	9																									
FIGURA N° 37: MANUBRIO	PÁ G.N° 21	FIGURA N° 38: LEVA DE CLUTCH	PÁ G.N° 22																								
	<table border="1" style="width: 100%; border-collapse: collapse;"> <thead> <tr> <th colspan="3" style="text-align: center;">COMPONENTES</th> </tr> </thead> <tbody> <tr><td style="text-align: center;">1</td><td style="text-align: center;">2</td><td style="text-align: center;">3</td></tr> <tr><td style="text-align: center;">4</td><td style="text-align: center;">5</td><td style="text-align: center;">6</td></tr> <tr><td style="text-align: center;">7</td><td style="text-align: center;">8</td><td style="text-align: center;">9</td></tr> </tbody> </table>	COMPONENTES			1	2	3	4	5	6	7	8	9		<table border="1" style="width: 100%; border-collapse: collapse;"> <thead> <tr> <th colspan="3" style="text-align: center;">COMPONENTES</th> </tr> </thead> <tbody> <tr><td style="text-align: center;">1</td><td style="text-align: center;">2</td><td style="text-align: center;">3</td></tr> <tr><td style="text-align: center;">4</td><td style="text-align: center;">5</td><td style="text-align: center;">6</td></tr> <tr><td style="text-align: center;">7</td><td style="text-align: center;">8</td><td style="text-align: center;">9</td></tr> </tbody> </table>	COMPONENTES			1	2	3	4	5	6	7	8	9
COMPONENTES																											
1	2	3																									
4	5	6																									
7	8	9																									
COMPONENTES																											
1	2	3																									
4	5	6																									
7	8	9																									
FIGURA N° 39: SOPORTE MANUBRIO	PÁ G.N° 23	FIGURA N° 40: LEVA DE FRENO	PÁ G.N° 24																								
	<table border="1" style="width: 100%; border-collapse: collapse;"> <thead> <tr> <th colspan="3" style="text-align: center;">COMPONENTES</th> </tr> </thead> <tbody> <tr><td style="text-align: center;">1</td><td style="text-align: center;">2</td><td style="text-align: center;">3</td></tr> <tr><td style="text-align: center;">4</td><td style="text-align: center;">5</td><td style="text-align: center;">6</td></tr> <tr><td style="text-align: center;">7</td><td style="text-align: center;">8</td><td style="text-align: center;">9</td></tr> </tbody> </table>	COMPONENTES			1	2	3	4	5	6	7	8	9		<table border="1" style="width: 100%; border-collapse: collapse;"> <thead> <tr> <th colspan="3" style="text-align: center;">COMPONENTES</th> </tr> </thead> <tbody> <tr><td style="text-align: center;">1</td><td style="text-align: center;">2</td><td style="text-align: center;">3</td></tr> <tr><td style="text-align: center;">4</td><td style="text-align: center;">5</td><td style="text-align: center;">6</td></tr> <tr><td style="text-align: center;">7</td><td style="text-align: center;">8</td><td style="text-align: center;">9</td></tr> </tbody> </table>	COMPONENTES			1	2	3	4	5	6	7	8	9
COMPONENTES																											
1	2	3																									
4	5	6																									
7	8	9																									
COMPONENTES																											
1	2	3																									
4	5	6																									
7	8	9																									
FIGURA N° 41: SOPORTE MODULO A BS	PÁ G.N° 25	FIGURA N° 42: TORNILLERÍA	PÁ G.N° 25																								

INDICE GRAFICOS



FIGURA N° 43: SOPORTE TUBOS SUSPENSIÓN DELA NTERA

PÁ G.N° 26



FIGURA N° 44: CUNA S DIRECCIÓN

PÁ G.N° 26



FIGURA N° 45: HORQUILLA DIRECCIÓN

PÁ G.N° 27



FIGURA N° 46:
FIGURA 46: BARRA S

PÁ G.N° 27



FIGURA N° 47: RUEDA DELA NTERA

PÁ G.N° 28











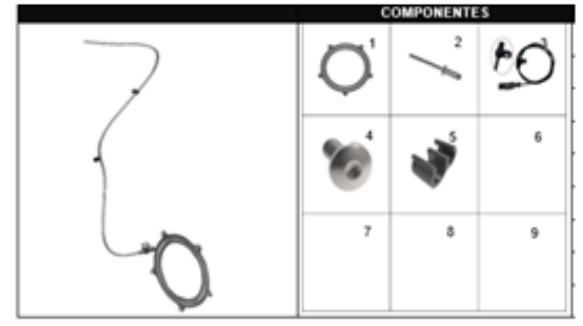



FIGURA N° 48: RUEDA FÓNICA, RUEDA DELA NTERA

PÁ G.N° 28

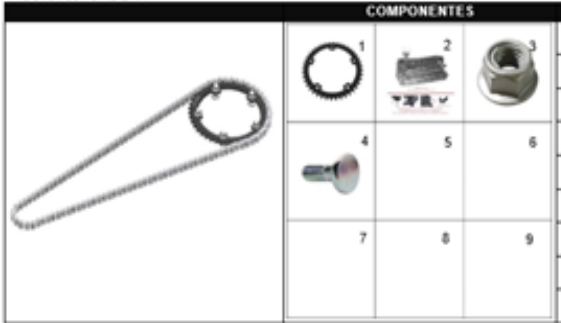





INDICE GRAFICOS

 <p style="text-align: center; font-weight: bold; font-size: small;">COMPONENTES</p>	 <p style="text-align: center; font-weight: bold; font-size: small;">COMPONENTES</p>	 <p style="text-align: center; font-weight: bold; font-size: small;">COMPONENTES</p>
<p>FIGURA N° 49: BRAZO OSCILANTE</p>	<p>FIGURA N° 50: DESLIZADOR CADENA</p>	<p>FIGURA N° 51: GUARDA BARRO TRA SERO INFERIOR INTERNO</p>
<p>PÁ G.N° 29</p>	<p>PÁ G.N° 30</p>	<p>PÁ G.N° 30</p>
 <p style="text-align: center; font-weight: bold; font-size: small;">COMPONENTES</p>	 <p style="text-align: center; font-weight: bold; font-size: small;">COMPONENTES</p>	 <p style="text-align: center; font-weight: bold; font-size: small;">COMPONENTES</p>
<p>FIGURA N° 52: A MORTIGUADOR TRA SERO</p>	<p>FIGURA N° 53: COMPLEMENTO TIJERA</p>	<p>FIGURA N° 54: PROTECTOR SPROCKET</p>
<p>PÁ G.N° 31</p>	<p>PÁ G.N° 31</p>	<p>PÁ G.N° 32</p>

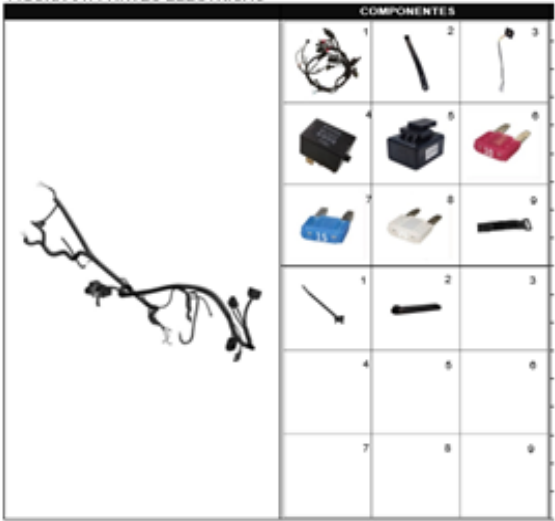
INDICE GRAFICOS

			
FIGURA N° 55: CADENA	PÁ G.N° 32	FIGURA N° 56: SOPORTE DENTADO BRAZO OSCILANTE	PÁ G.N° 33
			
FIGURA N° 58: EJE RUEDA TRA SERA	PÁ G.N° 34	FIGURA N° 59: RUEDA TRA SERA	PÁ G.N° 34
FIGURA N° 60: PARTES CHASIS	PÁ G.N° 35		

INDICE GRAFICOS

					
FIGURA N° 61: PARTES ELECTRICAS	PÁ G.N° 36	FIGURA N° 62: PITO Y SEGURO SILLIN	PÁ G.N° 37	FIGURA N° 63: REGULADOR	PÁ G.N° 37
					
FIGURA N° 64: CONTROLADOR ENCENDIDO Y CONTROLES	PÁ G.N° 38	FIGURA N° 65: SENSOR SOPORTE LATERAL	PÁ G.N° 38	FIGURA N° 66: SOPORTE MOTOR	PÁ G.N° 39

INDICE GRAFICOS



FIGURA N° 67: SOPORTE LATERAL

PÁG.N° 39



FIGURA N° 68: CAJA FILTRO DE AIRE

PÁG.N° 40



FIGURA N° 69: CUERPO DE INYECCIÓN

PÁG.N° 40



FIGURA N° 70: SOPORTE INYECTOR

PÁG.N° 4



FIGURA N° 71: MOTOR

PÁG.N° 41





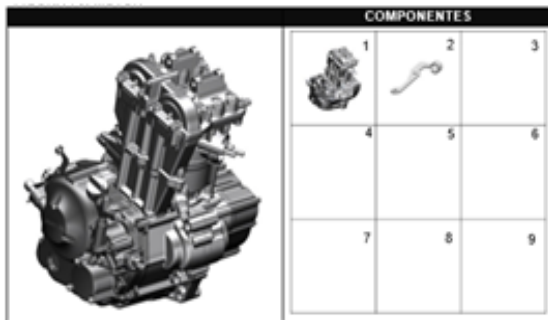





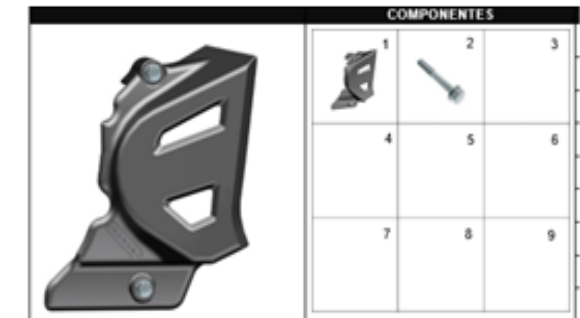

FIGURA N° 72: TAPA TRA SERA IZQUIERDA MOTOR

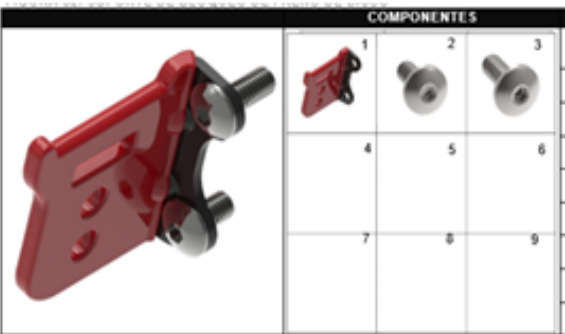
PÁG.N° 42

INDICE GRAFICOS

		
FIGURA N° 73: SILENCIADOR	FIGURA N° 74: PARTE TRA SERA SILENCIADOR	FIGURA N° 75: SOPORTE REPOSAPIES IZQUIERDA
		
FIGURA N° 76: REPOSAPIE DELA NTERO IZQUIERDO	FIGURA N° 77: SOPORTE DE BLOQUEO DE FRENO DE DISCO	FIGURA N° 78: MUÑON PEDAL DE CAMBIOS
PÁ G.N° 42	PÁ G.N° 43	PÁ G.N° 43
PÁ G.N° 44	PÁ G.N° 44	PÁ G.N° 45

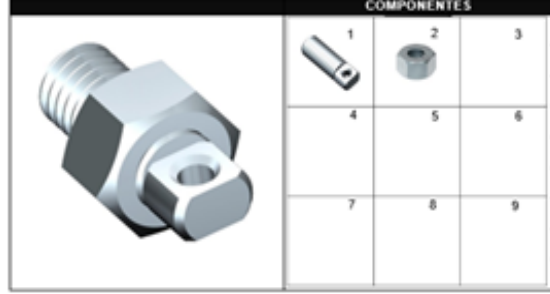
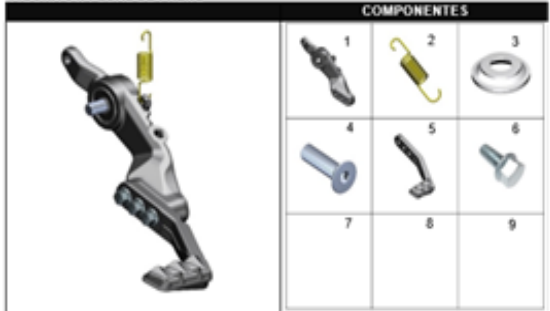
INDICE GRAFICOS

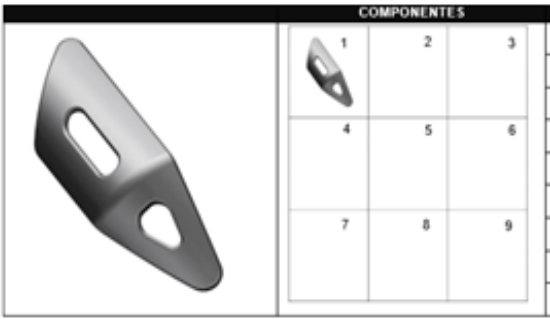
<div style="border: 1px solid black; padding: 5px;"> <p style="text-align: center; font-weight: bold; font-size: small;">COMPONENTES</p>  </div>	<div style="border: 1px solid black; padding: 5px;"> <p style="text-align: center; font-weight: bold; font-size: small;">COMPONENTES</p>  </div>	<div style="border: 1px solid black; padding: 5px;"> <p style="text-align: center; font-weight: bold; font-size: small;">COMPONENTES</p>  </div>			
<p>FIGURA N° 79: PEDAL DE CAMBIOS</p>	<p>PÁ G.N° 45</p>	<p>FIGURA N° 80: SOPORTE REPOSA PIES DERECHO</p>	<p>PÁ G.N° 46</p>	<p>FIGURA N° 81: TORNILLO PEDAL FRENO</p>	<p>PÁ G.N° 46</p>
<div style="border: 1px solid black; padding: 5px;"> <p style="text-align: center; font-weight: bold; font-size: small;">COMPONENTES</p>  </div>	<div style="border: 1px solid black; padding: 5px;"> <p style="text-align: center; font-weight: bold; font-size: small;">COMPONENTES</p>  </div>	<div style="border: 1px solid black; padding: 5px;"> <p style="text-align: center; font-weight: bold; font-size: small;">COMPONENTES</p>  </div>			
<p>FIGURA N° 82: PEDAL DE FRENO</p>	<p>PÁ G.N° 47</p>	<p>FIGURA N° 83: CUBIERTA BOMBA DE FRENO TRA SERO</p>	<p>PÁ G.N° 48</p>	<p>FIGURA N° 84: PLATINA MOFLE</p>	<p>PÁ G.N° 48</p>

INDICE GRAFICOS



FIGURA N° 85: A SE REPOSA PIE

PÁ G.N° 49

FIGURA N° 86: RA DIADOR

PÁ G.N° 49

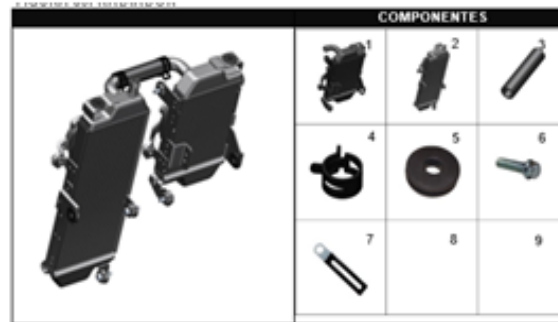
FIGURA N° 87: TAPA RADIADOR

PÁ G.N° 50



FIGURA N° 88: TA NQUE RESERVORIO

PÁ G.N° 50

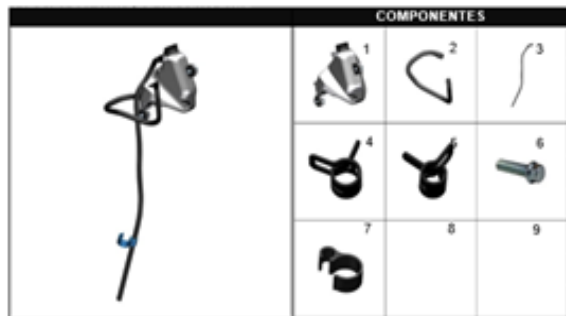

FIGURA N° 89: TERMOSTATO Y MANGUERA S

PÁ G.N° 51

FIGURA N° 90: RADIA DOR DE A CEITE

PÁ G.N° 52

INDICE GRAFICOS

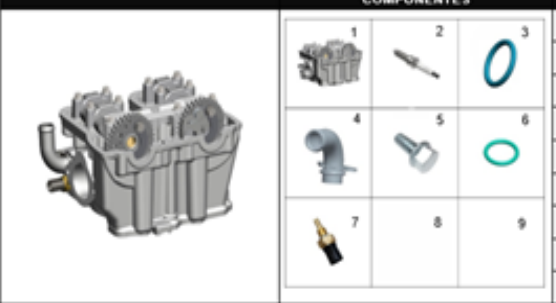
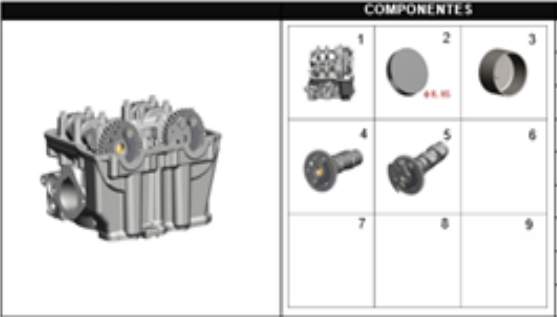
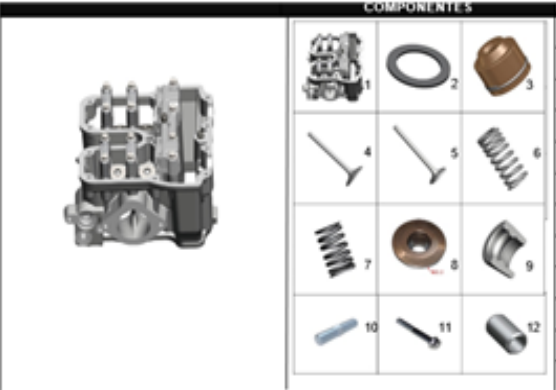
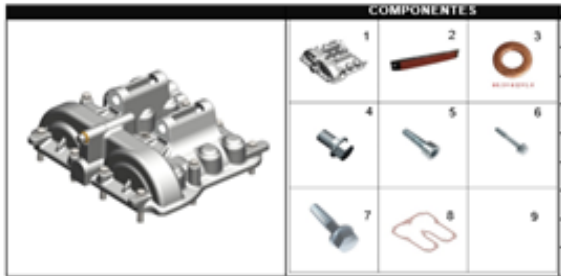
 <p style="text-align: center; font-weight: bold; font-size: small;">COMPONENTES</p>	 <p style="text-align: center; font-weight: bold; font-size: small;">COMPONENTES</p>	 <p style="text-align: center; font-weight: bold; font-size: small;">COMPONENTES</p>			
FIGURA N° 91: TUBO ENTRADA - SALIDA DE ACEITE	PÁ G.N° 52	FIGURA N° 92: CULATA	PÁ G.N° 53	FIGURA N° 93: CULATA	PÁ G.N° 54
 <p style="text-align: center; font-weight: bold; font-size: small;">COMPONENTES</p>	 <p style="text-align: center; font-weight: bold; font-size: small;">COMPONENTES</p>	 <p style="text-align: center; font-weight: bold; font-size: small;">COMPONENTES</p>			
FIGURA N° 94: CULATA	PÁ G.N° 54	FIGURA N° 95: CULATA	PÁ G.N° 55	FIGURA N° 96: TAPA CULATA	PÁ G.N° 55

INDICE GRAFICOS



FIGURA N° 97: KIT CILINDRO

PÁ G.N° 56



FIGURA N° 98: CILINDRO COMPLETO

PÁ G.N° 56



FIGURA N° 99: CILINDRO SOLO

PÁ G.N° 57



FIGURA N° 100: PISTÓN

PÁ G.N° 57



FIGURA N° 101: CLUTCH







PÁ G.N° 58

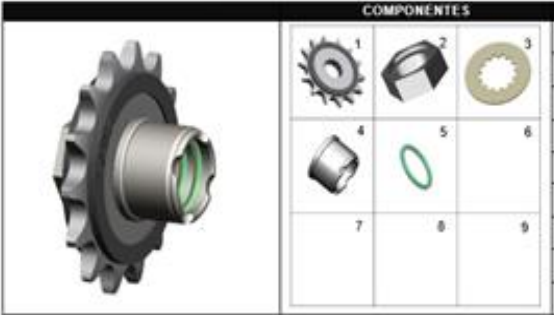

FIGURA N° 102: CLUTCH

PÁ G.N° 58





INDICE GRAFICOS

			
		<p>FIGURA N° 103: CLUTCH</p> <p style="text-align: right;">PÁ G.N° 59</p>	<p>FIGURA N° 104: TRANSMISIÓN</p> <p style="text-align: right;">PÁ G.N° 60</p>
<p>FIGURA N° 105: PIÑON DE SALIDA</p> <p style="text-align: right;">PÁ G.N° 60</p>	<p>FIGURA N° 106: EJE DE CAMBIOS</p> <p style="text-align: right;">PÁ G.N° 61</p>	<p>FIGURA N° 107: CARCA SA IZQUIERDA</p> <p style="text-align: right;">PÁ G.N° 62</p>	<p>FIGURA N° 108: CARCA SA IZQUIERDA</p> <p style="text-align: right;">PÁ G.N° 63</p>

INDICE GRAFICOS

 <table border="1" style="width: 100%; border-collapse: collapse; margin-top: 10px;"> <thead> <tr> <th colspan="3" style="text-align: center; font-size: small;">COMPONENTES</th> </tr> </thead> <tbody> <tr><td style="text-align: center;">1</td><td style="text-align: center;">2</td><td style="text-align: center;">3</td></tr> <tr><td style="text-align: center;">4</td><td style="text-align: center;">5</td><td style="text-align: center;">6</td></tr> <tr><td style="text-align: center;">7</td><td style="text-align: center;">8</td><td style="text-align: center;">9</td></tr> <tr><td style="text-align: center;">10</td><td style="text-align: center;">11</td><td style="text-align: center;">12</td></tr> <tr><td style="text-align: center;">13</td><td style="text-align: center;">14</td><td style="text-align: center;">15</td></tr> <tr><td style="text-align: center;">16</td><td style="text-align: center;">17</td><td style="text-align: center;">18</td></tr> <tr><td style="text-align: center;">19</td><td style="text-align: center;">20</td><td style="text-align: center;">21</td></tr> <tr><td style="text-align: center;">22</td><td style="text-align: center;">23</td><td style="text-align: center;">24</td></tr> <tr><td style="text-align: center;">25</td><td style="text-align: center;">26</td><td style="text-align: center;">27</td></tr> <tr><td style="text-align: center;">28</td><td style="text-align: center;">29</td><td style="text-align: center;">30</td></tr> <tr><td style="text-align: center;">31</td><td style="text-align: center;">32</td><td style="text-align: center;">33</td></tr> <tr><td style="text-align: center;">34</td><td style="text-align: center;">35</td><td style="text-align: center;">36</td></tr> <tr><td style="text-align: center;">37</td><td style="text-align: center;">38</td><td style="text-align: center;">39</td></tr> <tr><td style="text-align: center;">40</td><td style="text-align: center;">41</td><td style="text-align: center;">42</td></tr> <tr><td style="text-align: center;">43</td><td style="text-align: center;">44</td><td style="text-align: center;">45</td></tr> <tr><td style="text-align: center;">46</td><td style="text-align: center;">47</td><td style="text-align: center;">48</td></tr> <tr><td style="text-align: center;">49</td><td style="text-align: center;">50</td><td style="text-align: center;">51</td></tr> <tr><td style="text-align: center;">52</td><td style="text-align: center;">53</td><td style="text-align: center;">54</td></tr> <tr><td style="text-align: center;">55</td><td style="text-align: center;">56</td><td style="text-align: center;">57</td></tr> <tr><td style="text-align: center;">58</td><td style="text-align: center;">59</td><td style="text-align: center;">60</td></tr> <tr><td style="text-align: center;">61</td><td style="text-align: center;">62</td><td style="text-align: center;">63</td></tr> <tr><td style="text-align: center;">64</td><td style="text-align: center;">65</td><td style="text-align: center;">66</td></tr> <tr><td style="text-align: center;">67</td><td style="text-align: center;">68</td><td style="text-align: center;">69</td></tr> <tr><td style="text-align: center;">70</td><td style="text-align: center;">71</td><td style="text-align: center;">72</td></tr> <tr><td style="text-align: center;">73</td><td style="text-align: center;">74</td><td style="text-align: center;">75</td></tr> <tr><td style="text-align: center;">76</td><td style="text-align: center;">77</td><td style="text-align: center;">78</td></tr> <tr><td style="text-align: center;">79</td><td style="text-align: center;">80</td><td style="text-align: center;">81</td></tr> <tr><td style="text-align: center;">82</td><td style="text-align: center;">83</td><td style="text-align: center;">84</td></tr> <tr><td style="text-align: center;">85</td><td style="text-align: center;">86</td><td style="text-align: center;">87</td></tr> <tr><td style="text-align: center;">88</td><td style="text-align: center;">89</td><td style="text-align: center;">90</td></tr> <tr><td style="text-align: center;">91</td><td style="text-align: center;">92</td><td style="text-align: center;">93</td></tr> <tr><td style="text-align: center;">94</td><td style="text-align: center;">95</td><td style="text-align: center;">96</td></tr> <tr><td style="text-align: center;">97</td><td style="text-align: center;">98</td><td style="text-align: center;">99</td></tr> <tr><td style="text-align: center;">100</td><td style="text-align: center;">101</td><td style="text-align: center;">102</td></tr> <tr><td style="text-align: center;">103</td><td style="text-align: center;">104</td><td style="text-align: center;">105</td></tr> <tr><td style="text-align: center;">106</td><td style="text-align: center;">107</td><td style="text-align: center;">108</td></tr> <tr><td style="text-align: center;">109</td><td style="text-align: center;">110</td><td style="text-align: center;">111</td></tr> <tr><td style="text-align: center;">112</td><td style="text-align: center;">113</td><td style="text-align: center;">114</td></tr> <tr><td style="text-align: center;">115</td><td style="text-align: center;">116</td><td style="text-align: center;">117</td></tr> <tr><td style="text-align: center;">118</td><td style="text-align: center;">119</td><td style="text-align: center;">120</td></tr> <tr><td style="text-align: center;">121</td><td style="text-align: center;">122</td><td style="text-align: center;">123</td></tr> <tr><td style="text-align: center;">124</td><td style="text-align: center;">125</td><td style="text-align: center;">126</td></tr> <tr><td style="text-align: center;">127</td><td style="text-align: center;">128</td><td style="text-align: center;">129</td></tr> <tr><td style="text-align: center;">130</td><td style="text-align: center;">131</td><td style="text-align: center;">132</td></tr> <tr><td style="text-align: center;">133</td><td style="text-align: center;">134</td><td style="text-align: center;">135</td></tr> <tr><td style="text-align: center;">136</td><td style="text-align: center;">137</td><td style="text-align: center;">138</td></tr> <tr><td style="text-align: center;">139</td><td style="text-align: center;">140</td><td style="text-align: center;">141</td></tr> <tr><td style="text-align: center;">142</td><td style="text-align: center;">143</td><td style="text-align: center;">144</td></tr> <tr><td style="text-align: center;">145</td><td style="text-align: center;">146</td><td style="text-align: center;">147</td></tr> <tr><td style="text-align: center;">148</td><td style="text-align: center;">149</td><td style="text-align: center;">150</td></tr> <tr><td style="text-align: center;">151</td><td style="text-align: center;">152</td><td style="text-align: center;">153</td></tr> <tr><td style="text-align: center;">154</td><td style="text-align: center;">155</td><td style="text-align: center;">156</td></tr> <tr><td style="text-align: center;">157</td><td style="text-align: center;">158</td><td style="text-align: center;">159</td></tr> <tr><td style="text-align: center;">160</td><td style="text-align: center;">161</td><td style="text-align: center;">162</td></tr> <tr><td style="text-align: center;">163</td><td style="text-align: center;">164</td><td style="text-align: center;">165</td></tr> <tr><td style="text-align: center;">166</td><td style="text-align: center;">167</td><td style="text-align: center;">168</td></tr> <tr><td style="text-align: center;">169</td><td style="text-align: center;">170</td><td style="text-align: center;">171</td></tr> <tr><td style="text-align: center;">172</td><td style="text-align: center;">173</td><td style="text-align: center;">174</td></tr> <tr><td style="text-align: center;">175</td><td style="text-align: center;">176</td><td style="text-align: center;">177</td></tr> <tr><td style="text-align: center;">178</td><td style="text-align: center;">179</td><td style="text-align: center;">180</td></tr> <tr><td style="text-align: center;">181</td><td style="text-align: center;">182</td><td style="text-align: center;">183</td></tr> <tr><td style="text-align: center;">184</td><td style="text-align: center;">185</td><td style="text-align: center;">186</td></tr> <tr><td style="text-align: center;">187</td><td style="text-align: center;">188</td><td style="text-align: center;">189</td></tr> <tr><td style="text-align: center;">190</td><td style="text-align: center;">191</td><td style="text-align: center;">192</td></tr> <tr><td style="text-align: center;">193</td><td style="text-align: center;">194</td><td style="text-align: center;">195</td></tr> <tr><td style="text-align: center;">196</td><td style="text-align: center;">197</td><td style="text-align: center;">198</td></tr> <tr><td style="text-align: center;">199</td><td style="text-align: center;">200</td><td style="text-align: center;">201</td></tr> <tr><td style="text-align: center;">202</td><td style="text-align: center;">203</td><td style="text-align: center;">204</td></tr> <tr><td style="text-align: center;">205</td><td style="text-align: center;">206</td><td style="text-align: center;">207</td></tr> <tr><td style="text-align: center;">208</td><td style="text-align: center;">209</td><td style="text-align: center;">210</td></tr> <tr><td style="text-align: center;">211</td><td style="text-align: center;">212</td><td style="text-align: center;">213</td></tr> <tr><td style="text-align: center;">214</td><td style="text-align: center;">215</td><td style="text-align: center;">216</td></tr> <tr><td style="text-align: center;">217</td><td style="text-align: center;">218</td><td style="text-align: center;">219</td></tr> <tr><td style="text-align: center;">220</td><td style="text-align: center;">221</td><td style="text-align: center;">222</td></tr> <tr><td style="text-align: center;">223</td><td style="text-align: center;">224</td><td style="text-align: center;">225</td></tr> <tr><td style="text-align: center;">226</td><td style="text-align: center;">227</td><td style="text-align: center;">228</td></tr> <tr><td style="text-align: center;">229</td><td style="text-align: center;">230</td><td style="text-align: center;">231</td></tr> <tr><td style="text-align: center;">232</td><td style="text-align: center;">233</td><td style="text-align: center;">234</td></tr> <tr><td style="text-align: center;">235</td><td style="text-align: center;">236</td><td style="text-align: center;">237</td></tr> <tr><td style="text-align: center;">238</td><td style="text-align: center;">239</td><td style="text-align: center;">240</td></tr> <tr><td style="text-align: center;">241</td><td style="text-align: center;">242</td><td style="text-align: center;">243</td></tr> <tr><td style="text-align: center;">244</td><td style="text-align: center;">245</td><td style="text-align: center;">246</td></tr> <tr><td style="text-align: center;">247</td><td style="text-align: center;">248</td><td style="text-align: center;">249</td></tr> <tr><td style="text-align: center;">250</td><td style="text-align: center;">251</td><td style="text-align: center;">252</td></tr> <tr><td style="text-align: center;">253</td><td style="text-align: center;">254</td><td style="text-align: center;">255</td></tr> <tr><td style="text-align: center;">256</td><td style="text-align: center;">257</td><td style="text-align: center;">258</td></tr> <tr><td style="text-align: center;">259</td><td style="text-align: center;">260</td><td style="text-align: center;">261</td></tr> <tr><td style="text-align: center;">262</td><td style="text-align: center;">263</td><td style="text-align: center;">264</td></tr> <tr><td style="text-align: center;">265</td><td style="text-align: center;">266</td><td style="text-align: center;">267</td></tr> <tr><td style="text-align: center;">268</td><td style="text-align: center;">269</td><td style="text-align: center;">270</td></tr> <tr><td style="text-align: center;">271</td><td style="text-align: center;">272</td><td style="text-align: center;">273</td></tr> <tr><td style="text-align: center;">274</td><td style="text-align: center;">275</td><td style="text-align: center;">276</td></tr> <tr><td style="text-align: center;">277</td><td style="text-align: center;">278</td><td style="text-align: center;">279</td></tr> <tr><td style="text-align: center;">280</td><td style="text-align: center;">281</td><td style="text-align: center;">282</td></tr> <tr><td style="text-align: center;">283</td><td style="text-align: center;">284</td><td style="text-align: center;">285</td></tr> <tr><td style="text-align: center;">286</td><td style="text-align: center;">287</td><td style="text-align: center;">288</td></tr> <tr><td style="text-align: center;">289</td><td style="text-align: center;">290</td><td style="text-align: center;">291</td></tr> <tr><td style="text-align: center;">292</td><td style="text-align: center;">293</td><td style="text-align: center;">294</td></tr> <tr><td style="text-align: center;">295</td><td style="text-align: center;">296</td><td style="text-align: center;">297</td></tr> <tr><td style="text-align: center;">298</td><td style="text-align: center;">299</td><td style="text-align: center;">300</td></tr> <tr><td style="text-align: center;">301</td><td style="text-align: center;">302</td><td style="text-align: center;">303</td></tr> <tr><td style="text-align: center;">304</td><td style="text-align: center;">305</td><td style="text-align: center;">306</td></tr> <tr><td style="text-align: center;">307</td><td style="text-align: center;">308</td><td style="text-align: center;">309</td></tr> <tr><td style="text-align: center;">310</td><td style="text-align: center;">311</td><td style="text-align: center;">312</td></tr> <tr><td style="text-align: center;">313</td><td style="text-align: center;">314</td><td style="text-align: center;">315</td></tr> <tr><td style="text-align: center;">316</td><td style="text-align: center;">317</td><td style="text-align: center;">318</td></tr> <tr><td style="text-align: center;">319</td><td style="text-align: center;">320</td><td style="text-align: center;">321</td></tr> <tr><td style="text-align: center;">322</td><td style="text-align: center;">323</td><td style="text-align: center;">324</td></tr> <tr><td style="text-align: center;">325</td><td style="text-align: center;">326</td><td style="text-align: center;">327</td></tr> <tr><td style="text-align: center;">328</td><td style="text-align: center;">329</td><td style="text-align: center;">330</td></tr> <tr><td style="text-align: center;">331</td><td style="text-align: center;">332</td><td style="text-align: center;">333</td></tr> <tr><td style="text-align: center;">334</td><td style="text-align: center;">335</td><td style="text-align: center;">336</td></tr> <tr><td style="text-align: center;">337</td><td style="text-align: center;">338</td><td style="text-align: center;">339</td></tr> <tr><td style="text-align: center;">340</td><td style="text-align: center;">341</td><td style="text-align: center;">342</td></tr> <tr><td style="text-align: center;">343</td><td style="text-align: center;">344</td><td style="text-align: center;">345</td></tr> <tr><td style="text-align: center;">346</td><td style="text-align: center;">347</td><td style="text-align: center;">348</td></tr> <tr><td style="text-align: center;">349</td><td style="text-align: center;">350</td><td style="text-align: center;">351</td></tr> <tr><td style="text-align: center;">352</td><td style="text-align: center;">353</td><td style="text-align: center;">354</td></tr> <tr><td style="text-align: center;">355</td><td style="text-align: center;">356</td><td style="text-align: center;">357</td></tr> <tr><td style="text-align: center;">358</td><td style="text-align: center;">359</td><td style="text-align: center;">360</td></tr> <tr><td style="text-align: center;">361</td><td style="text-align: center;">362</td><td style="text-align: center;">363</td></tr> <tr><td style="text-align: center;">364</td><td style="text-align: center;">365</td><td style="text-align: center;">366</td></tr> <tr><td style="text-align: center;">367</td><td style="text-align: center;">368</td><td style="text-align: center;">369</td></tr> <tr><td style="text-align: center;">370</td><td style="text-align: center;">371</td><td style="text-align: center;">372</td></tr> <tr><td style="text-align: center;">373</td><td style="text-align: center;">374</td><td style="text-align: center;">375</td></tr> <tr><td style="text-align: center;">376</td><td style="text-align: center;">377</td><td style="text-align: center;">378</td></tr> <tr><td style="text-align: center;">379</td><td style="text-align: center;">380</td><td style="text-align: center;">381</td></tr> <tr><td style="text-align: center;">382</td><td style="text-align: center;">383</td><td style="text-align: center;">384</td></tr> <tr><td style="text-align: center;">385</td><td style="text-align: center;">386</td><td style="text-align: center;">387</td></tr> <tr><td style="text-align: center;">388</td><td style="text-align: center;">389</td><td style="text-align: center;">390</td></tr> <tr><td style="text-align: center;">391</td><td style="text-align: center;">392</td><td style="text-align: center;">393</td></tr> <tr><td style="text-align: center;">394</td><td style="text-align: center;">395</td><td style="text-align: center;">396</td></tr> <tr><td style="text-align: center;">397</td><td style="text-align: center;">398</td><td style="text-align: center;">399</td></tr> <tr><td style="text-align: center;">400</td><td style="text-align: center;">401</td><td style="text-align: center;">402</td></tr> <tr><td style="text-align: center;">403</td><td style="text-align: center;">404</td><td style="text-align: center;">405</td></tr> <tr><td style="text-align: center;">406</td><td style="text-align: center;">407</td><td style="text-align: center;">408</td></tr> <tr><td style="text-align: center;">409</td><td style="text-align: center;">410</td><td style="text-align: center;">411</td></tr> <tr><td style="text-align: center;">412</td><td style="text-align: center;">413</td><td style="text-align: center;">414</td></tr> <tr><td style="text-align: center;">415</td><td style="text-align: center;">416</td><td style="text-align: center;">417</td></tr> <tr><td style="text-align: center;">418</td><td style="text-align: center;">419</td><td style="text-align: center;">420</td></tr> <tr><td style="text-align: center;">421</td><td style="text-align: center;">422</td><td style="text-align: center;">423</td></tr> <tr><td style="text-align: center;">424</td><td style="text-align: center;">425</td><td style="text-align: center;">426</td></tr> <tr><td style="text-align: center;">427</td><td style="text-align: center;">428</td><td style="text-align: center;">429</td></tr> <tr><td style="text-align: center;">430</td><td style="text-align: center;">431</td><td style="text-align: center;">432</td></tr> <tr><td style="text-align: center;">433</td><td style="text-align: center;">434</td><td style="text-align: center;">435</td></tr> <tr><td style="text-align: center;">436</td><td style="text-align: center;">437</td><td style="text-align: center;">438</td></tr> <tr><td style="text-align: center;">439</td><td style="text-align: center;">440</td><td style="text-align: center;">441</td></tr> <tr><td style="text-align: center;">442</td><td style="text-align: center;">443</td><td style="text-align: center;">444</td></tr> <tr><td style="text-align: center;">445</td><td style="text-align: center;">446</td><td style="text-align: center;">447</td></tr> <tr><td style="text-align: center;">448</td><td style="text-align: center;">449</td><td style="text-align: center;">450</td></tr> <tr><td style="text-align: center;">451</td><td style="text-align: center;">452</td><td style="text-align: center;">453</td></tr> <tr><td style="text-align: center;">454</td><td style="text-align: center;">455</td><td style="text-align: center;">456</td></tr> <tr><td style="text-align: center;">457</td><td style="text-align: center;">458</td><td style="text-align: center;">459</td></tr> <tr><td style="text-align: center;">460</td><td style="text-align: center;">461</td><td style="text-align: center;">462</td></tr> <tr><td style="text-align: center;">463</td><td style="text-align: center;">464</td><td style="text-align: center;">465</td></tr> <tr><td style="text-align: center;">466</td><td style="text-align: center;">467</td><td style="text-align: center;">468</td></tr> <tr><td style="text-align: center;">469</td><td style="text-align: center;">470</td><td style="text-align: center;">471</td></tr> <tr><td style="text-align: center;">472</td><td style="text-align: center;">473</td><td style="text-align: center;">474</td></tr> <tr><td style="text-align: center;">475</td><td style="text-align: center;">476</td><td style="text-align: center;">477</td></tr> <tr><td style="text-align: center;">478</td><td style="text-align: center;">479</td><td style="text-align: center;">480</td></tr> <tr><td style="text-align: center;">481</td><td style="text-align: center;">482</td><td style="text-align: center;">483</td></tr> <tr><td style="text-align: center;">484</td><td style="text-align: center;">485</td><td style="text-align: center;">486</td></tr> <tr><td style="text-align: center;">487</td><td style="text-align: center;">488</td><td style="text-align: center;">489</td></tr> <tr><td style="text-align: center;">490</td><td style="text-align: center;">491</td><td style="text-align: center;">492</td></tr> <tr><td style="text-align: center;">493</td><td style="text-align: center;">494</td><td style="text-align: center;">495</td></tr> <tr><td style="text-align: center;">496</td><td style="text-align: center;">497</td><td style="text-align: center;">498</td></tr> <tr><td style="text-align: center;">499</td><td style="text-align: center;">500</td><td style="text-align: center;">501</td></tr> <tr><td style="text-align: center;">502</td><td style="text-align: center;">503</td><td style="text-align: center;">504</td></tr> <tr><td style="text-align: center;">505</td><td style="text-align: center;">506</td><td style="text-align: center;">507</td></tr> <tr><td style="text-align: center;">508</td><td style="text-align: center;">509</td><td style="text-align: center;">510</td></tr> <tr><td style="text-align: center;">511</td><td style="text-align: center;">512</td><td style="text-align: center;">513</td></tr> <tr><td style="text-align: center;">514</td><td style="text-align: center;">515</td><td style="text-align: center;">516</td></tr> <tr><td style="text-align: center;">517</td><td style="text-align: center;">518</td><td style="text-align: center;">519</td></tr> <tr><td style="text-align: center;">520</td><td style="text-align: center;">521</td><td style="text-align: center;">522</td></tr> <tr><td style="text-align: center;">523</td><td style="text-align: center;">524</td><td style="text-align: center;">525</td></tr> <tr><td style="text-align: center;">526</td><td style="text-align: center;">527</td><td style="text-align: center;">528</td></tr> <tr><td style="text-align: center;">529</td><td style="text-align: center;">530</td><td style="text-align: center;">531</td></tr> <tr><td style="text-align: center;">532</td><td style="text-align: center;">533</td><td style="text-align: center;">534</td></tr> <tr><td style="text-align: center;">535</td><td style="text-align: center;">536</td><td style="text-align: center;">537</td></tr> <tr><td style="text-align: center;">538</td><td style="text-align: center;">539</td><td style="text-align: center;">540</td></tr> <tr><td style="text-align: center;">541</td><td style="text-align: center;">542</td><td style="text-align: center;">543</td></tr> <tr><td style="text-align: center;">544</td><td style="text-align: center;">545</td><td style="text-align: center;">546</td></tr> <tr><td style="text-align: center;">547</td><td style="text-align: center;">548</td><td style="text-align: center;">549</td></tr> <tr><td style="text-align: center;">550</td><td style="text-align: center;">551</td><td style="text-align: center;">552</td></tr> <tr><td style="text-align: center;">553</td><td style="text-align: center;">554</td><td style="text-align: center;">555</td></tr> <tr><td style="text-align: center;">556</td><td style="text-align: center;">557</td><td style="text-align: center;">558</td></tr> <tr><td style="text-align: center;">559</td><td style="text-align: center;">560</td><td style="text-align: center;">561</td></tr> <tr><td style="text-align: center;">562</td><td style="text-align: center;">563</td><td style="text-align: center;">564</td></tr> <tr><td style="text-align: center;">565</td><td style="text-align: center;">566</td><td style="text-align: center;">567</td></tr> <tr><td style="text-align: center;">568</td><td style="text-align: center;">569</td><td style="text-align: center;">570</td></tr> <tr><td style="text-align: center;">571</td><td style="text-align: center;">572</td><td style="text-align: center;">573</td></tr> <tr><td style="text-align: center;">574</td><td style="text-align: center;">575</td><td style="text-align: center;">576</td></tr> <tr><td style="text-align: center;">577</td><td style="text-align: center;">578</td><td style="text-align: center;">579</td></tr> <tr><td style="text-align: center;">580</td><td style="text-align: center;">581</td><td style="text-align: center;">582</td></tr> <tr><td style="text-align: center;">583</td><td style="text-align: center;">584</td><td style="text-align: center;">585</td></tr> <tr><td style="text-align: center;">586</td><td style="text-align: center;">587</td><td style="text-align: center;">588</td></tr> <tr><td style="text-align: center;">589</td><td style="text-align: center;">590</td><td style="text-align: center;">591</td></tr> <tr><td style="text-align: center;">592</td><td style="text-align: center;">593</td><td style="text-align: center;">594</td></tr> <tr><td style="text-align: center;">595</td><td style="text-align: center;">596</td><td style="text-align: center;">597</td></tr> <tr><td style="text-align: center;">598</td><td style="text-align: center;">599</td><td style="text-align: center;">600</td></tr> <tr><td style="text-align: center;">601</td><td style="text-align: center;">602</td><td style="text-align: center;">603</td></tr> <tr><td style="text-align: center;">604</td><td style="text-align: center;">605</td><td style="text-align: center;">606</td></tr> <tr><td style="text-align: center;">607</td><td style="text-align: center;">608</td><td style="text-align: center;">609</td></tr> <tr><td style="text-align: center;">610</td><td style="text-align: center;">611</td><td style="text-align: center;">612</td></tr> <tr><td style="text-align: center;">613</td><td style="text-align: center;">614</td><td style="text-align: center;">615</td></tr> <tr><td style="text-align: center;">616</td><td style="text-align: center;">617</td><td style="text-align: center;">618</td></tr> <tr><td style="text-align: center;">619</td><td style="text-align: center;">620</td><td style="text-align: center;">621</td></tr> <tr><td style="text-align: center;">622</td><td style="text-align: center;">623</td><td style="text-align: center;">624</td></tr> <tr><td style="text-align: center;">625</td><td style="text-align: center;">626</td><td style="text-align: center;">627</td></tr> <tr><td style="text-align: center;">628</td><td style="text-align: center;">629</td><td style="text-align: center;">630</td></tr> <tr><td style="text-align: center;">631</td><td style="text-align: center;">632</td><td style="text-align: center;">633</td></tr> <tr><td style="text-align: center;">634</td><td style="text-align: center;">635</td><td style="text-align: center;">636</td></tr> <tr><td style="text-align: center;">637</td><td style="text-align: center;">638</td><td style="text-align: center;">639</td></tr> <tr><td style="text-align: center;">640</td><td style="text-align: center;">641</td><td style="text-align: center;">642</td></tr> <tr><td style="text-align: center;">643</td><td style="text-align: center;">644</td><td style="text-align: center;">645</td></tr> <tr><td style="text-align: center;">646</td><td style="text-align: center;">647</td><td style="text-align: center;">648</td></tr> <tr><td style="text-align: center;">649</td><td style="text-align: center;">650</td><td style="text-align: center;">651</td></tr> <tr><td style="text-align: center;">652</td><td style="text-align: center;">653</td><td style="text-align: center;">654</td></tr> <tr><td style="text-align: center;">655</td><td style="text-align: center;">656</td><td style="text-align: center;">657</td></tr> <tr><td style="text-align: center;">658</td><td style="text-align: center;">659</td><td style="text-align: center;">660</td></tr> <tr><td style="text-align: center;">661</td><td style="text-align: center;">662</td><td style="text-align: center;">663</td></tr> <tr><td style="text-align: center;">664</td><td style="text-align: center;">665</td><td style="text-align: center;">666</td></tr> <tr><td style="text-align: center;">667</td><td style="text-align: center;">668</td><td style="text-align: center;">669</td></tr> <tr><td style="text-align: center;">670</td><td style="text-align: center;">671</td><td style="text-align: center;">672</td></tr> <tr><td style="text-align: center;">673</td><td style="text-align: center;">674</td><td style="text-align: center;">675</td></tr> <tr><td style="text-align: center;">676</td><td style="text-align: center;">677</td><td style="text-align: center;">678</td></tr> <tr><td style="text-align: center;">679</td><td style="text-align: center;">680</td><td style="text-align: center;">681</td></tr> <tr><td style="text-align: center;">682</td><td style="text-align: center;">683</td><td style="text-align: center;">684</td></tr> <tr><td style="text-align: center;">685</td><td style="text-align: center;">686</td><td style="text-align: center;">687</td></tr> <tr><td style="text-align: center;">688</td><td style="text-align: center;">689</td><td style="text-align: center;">690</td></tr> <tr><td style="text-align: center;">691</td><td style="text-align: center;">692</td><td style="text-align: center;">693</td></tr> <tr><td style="text-align: center;">694</td><td style="text-align: center;">695</td><td style="text-align: center;">696</td></tr> <tr><td style="text-align: center;">697</td><td style="text-align: center;">698</td><td style="text-align: center;">699</td></tr> <tr><td style="text-align: center;">700</td><td style="text-align: center;">701</td><td style="text-align: center;">702</td></tr> <tr><td style="text-align: center;">703</td><td style="text-align: center;">704</td><td style="text-align: center;">705</td></tr> <tr><td style="text-align: center;">706</td><td style="text-align: center;">707</td><td style="text-align: center;">708</td></tr> <tr><td style="text-align: center;">709</td><td style="text-align: center;">710</td><td style="text-align: center;">711</td></tr> <tr><td style="text-align: center;">712</td><td style="text-align: center;">713</td><td style="text-align: center;">714</td></tr> <tr><td style="text-align: center;">715</td><td style="text-align: center;">716</td><td style="text-align: center;">717</td></tr> <tr><td style="text-align: center;">718</td><td style="text-align: center;">719</td><td style="text-align: center;">720</td></tr> <tr><td style="text-align: center;">721</td><td style="text-align: center;">722</td><td style="text-align: center;">723</td></tr> <tr><td style="text-align: center;">724</td><td style="text-align: center;">725</td><td style="text-align: center;">726</td></tr> <tr><td style="text-align: center;">727</td><td style="text-align: center;">728</td><td style="text-align: center;">729</td></tr> <tr><td style="text-align: center;">730</td><td style="text-align: center;">731</td><td style="text-align: center;">732</td></tr> <tr><td style="text-align: center;">733</td><td style="text-align: center;">734</td><td style="text-align: center;">735</td></tr> <tr><td style="text-align: center;">736</td><td style="text-align: center;">737</td><td style="text-align: center;">738</td></tr> <tr><td style="text-align: center;">739</td><td style="text-align: center;">740</td><td style="text-align: center;">741</td></tr> <tr><td style="text-align: center;">742</td><td style="text-align: center;">743</td><td style="text-align: center;">744</td></tr> <tr><td style="text-align: center;">745</td><td style="text-align: center;">746</td><td style="text-align: center;">747</td></tr> <tr><td style="text-align: center;">748</td><td style="text-align: center;">749</td><td style="text-align: center;">750</td></tr> <tr><td style="text-align: center;">751</td><td style="text-align: center;">752</td><td style="text-align: center;">753</td></tr> <tr><td style="text-align: center;">754</td><td style="text-align: center;">755</td><td style="text-align: center;">756</td></tr> <tr><td style="text-align: center;">757</td><td style="text-align: center;">758</td><td style="text-align: center;">759</td></tr> <tr><td style="text-align: center;">760</td><td style="text-align: center;">761</td><td style="text-align: center;">762</td></tr> <tr><td style="text-align: center;">763</td><td style="text-align: center;">764</td><td style="text-align: center;">765</td></tr> <tr><td style="text-align: center;">766</td><td style="text-align: center;">767</td><td style="text-align: center;">768</td></tr> <tr><td style="text-align: center;">769</td><td style="text-align: center;">770</td><td style="text-align: center;">771</td></tr> <tr><td style="text-align: center;">772</td><td style="text-align: center;">773</td><td style="text-align: center;">774</td></tr> <tr><td style="text-align: center;">775</td><td style="text-align: center;">776</td><td style="text-align: center;">777</td></tr> <tr><td style="text-align: center;">778</td><td style="text-align: center;">779</td><td style="text-align: center;">780</td></tr> <tr><td style="text-align: center;">781</td><td style="text-align: center;">782</td></tr></tbody></table>	COMPONENTES			1	2	3	4	5	6	7	8	9	10	11	12	13	14	15	16	17	18	19	20	21	22	23	24	25	26	27	28	29	30	31	32	33	34	35	36	37	38	39	40	41	42	43	44	45	46	47	48	49	50	51	52	53	54	55	56	57	58	59	60	61	62	63	64	65	66	67	68	69	70	71	72	73	74	75	76	77	78	79	80	81	82	83	84	85	86	87	88	89	90	91	92	93	94	95	96	97	98	99	100	101	102	103	104	105	106	107	108	109	110	111	112	113	114	115	116	117	118	119	120	121	122	123	124	125	126	127	128	129	130	131	132	133	134	135	136	137	138	139	140	141	142	143	144	145	146	147	148	149	150	151	152	153	154	155	156	157	158	159	160	161	162	163	164	165	166	167	168	169	170	171	172	173	174	175	176	177	178	179	180	181	182	183	184	185	186	187	188	189	190	191	192	193	194	195	196	197	198	199	200	201	202	203	204	205	206	207	208	209	210	211	212	213	214	215	216	217	218	219	220	221	222	223	224	225	226	227	228	229	230	231	232	233	234	235	236	237	238	239	240	241	242	243	244	245	246	247	248	249	250	251	252	253	254	255	256	257	258	259	260	261	262	263	264	265	266	267	268	269	270	271	272	273	274	275	276	277	278	279	280	281	282	283	284	285	286	287	288	289	290	291	292	293	294	295	296	297	298	299	300	301	302	303	304	305	306	307	308	309	310	311	312	313	314	315	316	317	318	319	320	321	322	323	324	325	326	327	328	329	330	331	332	333	334	335	336	337	338	339	340	341	342	343	344	345	346	347	348	349	350	351	352	353	354	355	356	357	358	359	360	361	362	363	364	365	366	367	368	369	370	371	372	373	374	375	376	377	378	379	380	381	382	383	384	385	386	387	388	389	390	391	392	393	394	395	396	397	398	399	400	401	402	403	404	405	406	407	408	409	410	411	412	413	414	415	416	417	418	419	420	421	422	423	424	425	426	427	428	429	430	431	432	433	434	435	436	437	438	439	440	441	442	443	444	445	446	447	448	449	450	451	452	453	454	455	456	457	458	459	460	461	462	463	464	465	466	467	468	469	470	471	472	473	474	475	476	477	478	479	480	481	482	483	484	485	486	487	488	489	490	491	492	493	494	495	496	497	498	499	500	501	502	503	504	505	506	507	508	509	510	511	512	513	514	515	516	517	518	519	520	521	522	523	524	525	526	527	528	529	530	531	532	533	534	535	536	537	538	539	540	541	542	543	544	545	546	547	548	549	550	551	552	553	554	555	556	557	558	559	560	561	562	563	564	565	566	567	568	569	570	571	572	573	574	575	576	577	578	579	580	581	582	583	584	585	586	587	588	589	590	591	592	593	594	595	596	597	598	599	600	601	602	603	604	605	606	607	608	609	610	611	612	613	614	615	616	617	618	619	620	621	622	623	624	625	626	627	628	629	630	631	632	633	634	635	636	637	638	639	640	641	642	643	644	645	646	647	648	649	650	651	652	653	654	655	656	657	658	659	660	661	662	663	664	665	666	667	668	669	670	671	672	673	674	675	676	677	678	679	680	681	682	683	684	685	686	687	688	689	690	691	692	693	694	695	696	697	698	699	700	701	702	703	704	705	706	707	708	709	710	711	712	713	714	715	716	717	718	719	720	721	722	723	724	725	726	727	728	729	730	731	732	733	734	735	736	737	738	739	740	741	742	743	744	745	746	747	748	749	750	751	752	753	754	755	756	757	758	759	760	761	762	763	764	765	766	767	768	769	770	771	772	773	774	775	776	777	778	779	780	781	782
COMPONENTES																																																																																																																																																																																																																																																																																																																																																																																																																																																																																																																																																																																																																																																																																																																																																																																																																	
1	2	3																																																																																																																																																																																																																																																																																																																																																																																																																																																																																																																																																																																																																																																																																																																																																																																																															
4	5	6																																																																																																																																																																																																																																																																																																																																																																																																																																																																																																																																																																																																																																																																																																																																																																																																															
7	8	9																																																																																																																																																																																																																																																																																																																																																																																																																																																																																																																																																																																																																																																																																																																																																																																																															
10	11	12																																																																																																																																																																																																																																																																																																																																																																																																																																																																																																																																																																																																																																																																																																																																																																																																															
13	14	15																																																																																																																																																																																																																																																																																																																																																																																																																																																																																																																																																																																																																																																																																																																																																																																																															
16	17	18																																																																																																																																																																																																																																																																																																																																																																																																																																																																																																																																																																																																																																																																																																																																																																																																															
19	20	21																																																																																																																																																																																																																																																																																																																																																																																																																																																																																																																																																																																																																																																																																																																																																																																																															
22	23	24																																																																																																																																																																																																																																																																																																																																																																																																																																																																																																																																																																																																																																																																																																																																																																																																															
25	26	27																																																																																																																																																																																																																																																																																																																																																																																																																																																																																																																																																																																																																																																																																																																																																																																																															
28	29	30																																																																																																																																																																																																																																																																																																																																																																																																																																																																																																																																																																																																																																																																																																																																																																																																															
31	32	33																																																																																																																																																																																																																																																																																																																																																																																																																																																																																																																																																																																																																																																																																																																																																																																																															
34	35	36																																																																																																																																																																																																																																																																																																																																																																																																																																																																																																																																																																																																																																																																																																																																																																																																															
37	38	39																																																																																																																																																																																																																																																																																																																																																																																																																																																																																																																																																																																																																																																																																																																																																																																																															
40	41	42																																																																																																																																																																																																																																																																																																																																																																																																																																																																																																																																																																																																																																																																																																																																																																																																															
43	44	45																																																																																																																																																																																																																																																																																																																																																																																																																																																																																																																																																																																																																																																																																																																																																																																																															
46	47	48																																																																																																																																																																																																																																																																																																																																																																																																																																																																																																																																																																																																																																																																																																																																																																																																															
49	50	51																																																																																																																																																																																																																																																																																																																																																																																																																																																																																																																																																																																																																																																																																																																																																																																																															
52	53	54																																																																																																																																																																																																																																																																																																																																																																																																																																																																																																																																																																																																																																																																																																																																																																																																															
55	56	57																																																																																																																																																																																																																																																																																																																																																																																																																																																																																																																																																																																																																																																																																																																																																																																																															
58	59	60																																																																																																																																																																																																																																																																																																																																																																																																																																																																																																																																																																																																																																																																																																																																																																																																															
61	62	63																																																																																																																																																																																																																																																																																																																																																																																																																																																																																																																																																																																																																																																																																																																																																																																																															
64	65	66																																																																																																																																																																																																																																																																																																																																																																																																																																																																																																																																																																																																																																																																																																																																																																																																															
67	68	69																																																																																																																																																																																																																																																																																																																																																																																																																																																																																																																																																																																																																																																																																																																																																																																																															
70	71	72																																																																																																																																																																																																																																																																																																																																																																																																																																																																																																																																																																																																																																																																																																																																																																																																															
73	74	75																																																																																																																																																																																																																																																																																																																																																																																																																																																																																																																																																																																																																																																																																																																																																																																																															
76	77	78																																																																																																																																																																																																																																																																																																																																																																																																																																																																																																																																																																																																																																																																																																																																																																																																															
79	80	81																																																																																																																																																																																																																																																																																																																																																																																																																																																																																																																																																																																																																																																																																																																																																																																																															
82	83	84																																																																																																																																																																																																																																																																																																																																																																																																																																																																																																																																																																																																																																																																																																																																																																																																															
85	86	87																																																																																																																																																																																																																																																																																																																																																																																																																																																																																																																																																																																																																																																																																																																																																																																																															
88	89	90																																																																																																																																																																																																																																																																																																																																																																																																																																																																																																																																																																																																																																																																																																																																																																																																															
91	92	93																																																																																																																																																																																																																																																																																																																																																																																																																																																																																																																																																																																																																																																																																																																																																																																																															
94	95	96																																																																																																																																																																																																																																																																																																																																																																																																																																																																																																																																																																																																																																																																																																																																																																																																															
97	98	99																																																																																																																																																																																																																																																																																																																																																																																																																																																																																																																																																																																																																																																																																																																																																																																																															
100	101	102																																																																																																																																																																																																																																																																																																																																																																																																																																																																																																																																																																																																																																																																																																																																																																																																															
103	104	105																																																																																																																																																																																																																																																																																																																																																																																																																																																																																																																																																																																																																																																																																																																																																																																																															
106	107	108																																																																																																																																																																																																																																																																																																																																																																																																																																																																																																																																																																																																																																																																																																																																																																																																															
109	110	111																																																																																																																																																																																																																																																																																																																																																																																																																																																																																																																																																																																																																																																																																																																																																																																																															
112	113	114																																																																																																																																																																																																																																																																																																																																																																																																																																																																																																																																																																																																																																																																																																																																																																																																															
115	116	117																																																																																																																																																																																																																																																																																																																																																																																																																																																																																																																																																																																																																																																																																																																																																																																																															
118	119	120																																																																																																																																																																																																																																																																																																																																																																																																																																																																																																																																																																																																																																																																																																																																																																																																															
121	122	123																																																																																																																																																																																																																																																																																																																																																																																																																																																																																																																																																																																																																																																																																																																																																																																																															
124	125	126																																																																																																																																																																																																																																																																																																																																																																																																																																																																																																																																																																																																																																																																																																																																																																																																															
127	128	129																																																																																																																																																																																																																																																																																																																																																																																																																																																																																																																																																																																																																																																																																																																																																																																																															
130	131	132																																																																																																																																																																																																																																																																																																																																																																																																																																																																																																																																																																																																																																																																																																																																																																																																															
133	134	135																																																																																																																																																																																																																																																																																																																																																																																																																																																																																																																																																																																																																																																																																																																																																																																																															
136	137	138																																																																																																																																																																																																																																																																																																																																																																																																																																																																																																																																																																																																																																																																																																																																																																																																															
139	140	141																																																																																																																																																																																																																																																																																																																																																																																																																																																																																																																																																																																																																																																																																																																																																																																																															
142	143	144																																																																																																																																																																																																																																																																																																																																																																																																																																																																																																																																																																																																																																																																																																																																																																																																															
145	146	147																																																																																																																																																																																																																																																																																																																																																																																																																																																																																																																																																																																																																																																																																																																																																																																																															
148	149	150																																																																																																																																																																																																																																																																																																																																																																																																																																																																																																																																																																																																																																																																																																																																																																																																															
151	152	153																																																																																																																																																																																																																																																																																																																																																																																																																																																																																																																																																																																																																																																																																																																																																																																																															
154	155	156																																																																																																																																																																																																																																																																																																																																																																																																																																																																																																																																																																																																																																																																																																																																																																																																															
157	158	159																																																																																																																																																																																																																																																																																																																																																																																																																																																																																																																																																																																																																																																																																																																																																																																																															
160	161	162																																																																																																																																																																																																																																																																																																																																																																																																																																																																																																																																																																																																																																																																																																																																																																																																															
163	164	165																																																																																																																																																																																																																																																																																																																																																																																																																																																																																																																																																																																																																																																																																																																																																																																																															
166	167	168																																																																																																																																																																																																																																																																																																																																																																																																																																																																																																																																																																																																																																																																																																																																																																																																															
169	170	171																																																																																																																																																																																																																																																																																																																																																																																																																																																																																																																																																																																																																																																																																																																																																																																																															
172	173	174																																																																																																																																																																																																																																																																																																																																																																																																																																																																																																																																																																																																																																																																																																																																																																																																															
175	176	177																																																																																																																																																																																																																																																																																																																																																																																																																																																																																																																																																																																																																																																																																																																																																																																																															
178	179	180																																																																																																																																																																																																																																																																																																																																																																																																																																																																																																																																																																																																																																																																																																																																																																																																															
181	182	183																																																																																																																																																																																																																																																																																																																																																																																																																																																																																																																																																																																																																																																																																																																																																																																																															
184	185	186																																																																																																																																																																																																																																																																																																																																																																																																																																																																																																																																																																																																																																																																																																																																																																																																															
187	188	189																																																																																																																																																																																																																																																																																																																																																																																																																																																																																																																																																																																																																																																																																																																																																																																																															
190	191	192																																																																																																																																																																																																																																																																																																																																																																																																																																																																																																																																																																																																																																																																																																																																																																																																															
193	194	195																																																																																																																																																																																																																																																																																																																																																																																																																																																																																																																																																																																																																																																																																																																																																																																																															
196	197	198																																																																																																																																																																																																																																																																																																																																																																																																																																																																																																																																																																																																																																																																																																																																																																																																															
199	200	201																																																																																																																																																																																																																																																																																																																																																																																																																																																																																																																																																																																																																																																																																																																																																																																																															
202	203	204																																																																																																																																																																																																																																																																																																																																																																																																																																																																																																																																																																																																																																																																																																																																																																																																															
205	206	207																																																																																																																																																																																																																																																																																																																																																																																																																																																																																																																																																																																																																																																																																																																																																																																																															
208	209	210																																																																																																																																																																																																																																																																																																																																																																																																																																																																																																																																																																																																																																																																																																																																																																																																															
211	212	213																																																																																																																																																																																																																																																																																																																																																																																																																																																																																																																																																																																																																																																																																																																																																																																																															
214	215	216																																																																																																																																																																																																																																																																																																																																																																																																																																																																																																																																																																																																																																																																																																																																																																																																															
217	218	219																																																																																																																																																																																																																																																																																																																																																																																																																																																																																																																																																																																																																																																																																																																																																																																																															
220	221	222																																																																																																																																																																																																																																																																																																																																																																																																																																																																																																																																																																																																																																																																																																																																																																																																															
223	224	225																																																																																																																																																																																																																																																																																																																																																																																																																																																																																																																																																																																																																																																																																																																																																																																																															
226	227	228																																																																																																																																																																																																																																																																																																																																																																																																																																																																																																																																																																																																																																																																																																																																																																																																															
229	230	231																																																																																																																																																																																																																																																																																																																																																																																																																																																																																																																																																																																																																																																																																																																																																																																																															
232	233	234																																																																																																																																																																																																																																																																																																																																																																																																																																																																																																																																																																																																																																																																																																																																																																																																															
235	236	237																																																																																																																																																																																																																																																																																																																																																																																																																																																																																																																																																																																																																																																																																																																																																																																																															
238	239	240																																																																																																																																																																																																																																																																																																																																																																																																																																																																																																																																																																																																																																																																																																																																																																																																															
241	242	243																																																																																																																																																																																																																																																																																																																																																																																																																																																																																																																																																																																																																																																																																																																																																																																																															
244	245	246																																																																																																																																																																																																																																																																																																																																																																																																																																																																																																																																																																																																																																																																																																																																																																																																															
247	248	249																																																																																																																																																																																																																																																																																																																																																																																																																																																																																																																																																																																																																																																																																																																																																																																																															
250	251	252																																																																																																																																																																																																																																																																																																																																																																																																																																																																																																																																																																																																																																																																																																																																																																																																															
253	254	255																																																																																																																																																																																																																																																																																																																																																																																																																																																																																																																																																																																																																																																																																																																																																																																																															
256	257	258																																																																																																																																																																																																																																																																																																																																																																																																																																																																																																																																																																																																																																																																																																																																																																																																															
259	260	261																																																																																																																																																																																																																																																																																																																																																																																																																																																																																																																																																																																																																																																																																																																																																																																																															
262	263	264																																																																																																																																																																																																																																																																																																																																																																																																																																																																																																																																																																																																																																																																																																																																																																																																															
265	266	267																																																																																																																																																																																																																																																																																																																																																																																																																																																																																																																																																																																																																																																																																																																																																																																																															
268	269	270																																																																																																																																																																																																																																																																																																																																																																																																																																																																																																																																																																																																																																																																																																																																																																																																															
271	272	273																																																																																																																																																																																																																																																																																																																																																																																																																																																																																																																																																																																																																																																																																																																																																																																																															
274	275	276																																																																																																																																																																																																																																																																																																																																																																																																																																																																																																																																																																																																																																																																																																																																																																																																															
277	278	279																																																																																																																																																																																																																																																																																																																																																																																																																																																																																																																																																																																																																																																																																																																																																																																																															
280	281	282																																																																																																																																																																																																																																																																																																																																																																																																																																																																																																																																																																																																																																																																																																																																																																																																															
283	284	285																																																																																																																																																																																																																																																																																																																																																																																																																																																																																																																																																																																																																																																																																																																																																																																																															
286	287	288																																																																																																																																																																																																																																																																																																																																																																																																																																																																																																																																																																																																																																																																																																																																																																																																															
289	290	291																																																																																																																																																																																																																																																																																																																																																																																																																																																																																																																																																																																																																																																																																																																																																																																																															
292	293	294																																																																																																																																																																																																																																																																																																																																																																																																																																																																																																																																																																																																																																																																																																																																																																																																															
295	296	297																																																																																																																																																																																																																																																																																																																																																																																																																																																																																																																																																																																																																																																																																																																																																																																																															
298	299	300																																																																																																																																																																																																																																																																																																																																																																																																																																																																																																																																																																																																																																																																																																																																																																																																															
301	302	303																																																																																																																																																																																																																																																																																																																																																																																																																																																																																																																																																																																																																																																																																																																																																																																																															
304	305	306																																																																																																																																																																																																																																																																																																																																																																																																																																																																																																																																																																																																																																																																																																																																																																																																															
307	308	309																																																																																																																																																																																																																																																																																																																																																																																																																																																																																																																																																																																																																																																																																																																																																																																																															
310	311	312																																																																																																																																																																																																																																																																																																																																																																																																																																																																																																																																																																																																																																																																																																																																																																																																															
313	314	315																																																																																																																																																																																																																																																																																																																																																																																																																																																																																																																																																																																																																																																																																																																																																																																																															
316	317	318																																																																																																																																																																																																																																																																																																																																																																																																																																																																																																																																																																																																																																																																																																																																																																																																															
319	320	321																																																																																																																																																																																																																																																																																																																																																																																																																																																																																																																																																																																																																																																																																																																																																																																																															
322	323	324																																																																																																																																																																																																																																																																																																																																																																																																																																																																																																																																																																																																																																																																																																																																																																																																															
325	326	327																																																																																																																																																																																																																																																																																																																																																																																																																																																																																																																																																																																																																																																																																																																																																																																																															
328	329	330																																																																																																																																																																																																																																																																																																																																																																																																																																																																																																																																																																																																																																																																																																																																																																																																															
331	332	333																																																																																																																																																																																																																																																																																																																																																																																																																																																																																																																																																																																																																																																																																																																																																																																																															
334	335	336																																																																																																																																																																																																																																																																																																																																																																																																																																																																																																																																																																																																																																																																																																																																																																																																															
337	338	339																																																																																																																																																																																																																																																																																																																																																																																																																																																																																																																																																																																																																																																																																																																																																																																																															
340	341	342																																																																																																																																																																																																																																																																																																																																																																																																																																																																																																																																																																																																																																																																																																																																																																																																															
343	344	345																																																																																																																																																																																																																																																																																																																																																																																																																																																																																																																																																																																																																																																																																																																																																																																																															
346	347	348																																																																																																																																																																																																																																																																																																																																																																																																																																																																																																																																																																																																																																																																																																																																																																																																															
349	350	351																																																																																																																																																																																																																																																																																																																																																																																																																																																																																																																																																																																																																																																																																																																																																																																																															
352	353	354																																																																																																																																																																																																																																																																																																																																																																																																																																																																																																																																																																																																																																																																																																																																																																																																															
355	356	357																																																																																																																																																																																																																																																																																																																																																																																																																																																																																																																																																																																																																																																																																																																																																																																																															
358	359	360																																																																																																																																																																																																																																																																																																																																																																																																																																																																																																																																																																																																																																																																																																																																																																																																															
361	362	363																																																																																																																																																																																																																																																																																																																																																																																																																																																																																																																																																																																																																																																																																																																																																																																																															
364	365	366																																																																																																																																																																																																																																																																																																																																																																																																																																																																																																																																																																																																																																																																																																																																																																																																															
367	368	369																																																																																																																																																																																																																																																																																																																																																																																																																																																																																																																																																																																																																																																																																																																																																																																																															
370	371	372																																																																																																																																																																																																																																																																																																																																																																																																																																																																																																																																																																																																																																																																																																																																																																																																															
373	374	375																																																																																																																																																																																																																																																																																																																																																																																																																																																																																																																																																																																																																																																																																																																																																																																																															
376	377	378																																																																																																																																																																																																																																																																																																																																																																																																																																																																																																																																																																																																																																																																																																																																																																																																															
379	380	381																																																																																																																																																																																																																																																																																																																																																																																																																																																																																																																																																																																																																																																																																																																																																																																																															
382	383	384																																																																																																																																																																																																																																																																																																																																																																																																																																																																																																																																																																																																																																																																																																																																																																																																															
385	386	387																																																																																																																																																																																																																																																																																																																																																																																																																																																																																																																																																																																																																																																																																																																																																																																																															
388	389	390																																																																																																																																																																																																																																																																																																																																																																																																																																																																																																																																																																																																																																																																																																																																																																																																															
391	392	393																																																																																																																																																																																																																																																																																																																																																																																																																																																																																																																																																																																																																																																																																																																																																																																																															
394	395	396																																																																																																																																																																																																																																																																																																																																																																																																																																																																																																																																																																																																																																																																																																																																																																																																															
397	398	399																																																																																																																																																																																																																																																																																																																																																																																																																																																																																																																																																																																																																																																																																																																																																																																																															
400	401	402																																																																																																																																																																																																																																																																																																																																																																																																																																																																																																																																																																																																																																																																																																																																																																																																															
403	404	405																																																																																																																																																																																																																																																																																																																																																																																																																																																																																																																																																																																																																																																																																																																																																																																																															
406	407	408																																																																																																																																																																																																																																																																																																																																																																																																																																																																																																																																																																																																																																																																																																																																																																																																															
409	410	411																																																																																																																																																																																																																																																																																																																																																																																																																																																																																																																																																																																																																																																																																																																																																																																																															
412	413	414																																																																																																																																																																																																																																																																																																																																																																																																																																																																																																																																																																																																																																																																																																																																																																																																															
415	416	417																																																																																																																																																																																																																																																																																																																																																																																																																																																																																																																																																																																																																																																																																																																																																																																																															
418	419	420																																																																																																																																																																																																																																																																																																																																																																																																																																																																																																																																																																																																																																																																																																																																																																																																															
421	422	423																																																																																																																																																																																																																																																																																																																																																																																																																																																																																																																																																																																																																																																																																																																																																																																																															
424	425	426																																																																																																																																																																																																																																																																																																																																																																																																																																																																																																																																																																																																																																																																																																																																																																																																															
427	428	429																																																																																																																																																																																																																																																																																																																																																																																																																																																																																																																																																																																																																																																																																																																																																																																																															
430	431	432																																																																																																																																																																																																																																																																																																																																																																																																																																																																																																																																																																																																																																																																																																																																																																																																															
433	434	435																																																																																																																																																																																																																																																																																																																																																																																																																																																																																																																																																																																																																																																																																																																																																																																																															
436	437	438																																																																																																																																																																																																																																																																																																																																																																																																																																																																																																																																																																																																																																																																																																																																																																																																															
439	440	441																																																																																																																																																																																																																																																																																																																																																																																																																																																																																																																																																																																																																																																																																																																																																																																																															
442	443	444																																																																																																																																																																																																																																																																																																																																																																																																																																																																																																																																																																																																																																																																																																																																																																																																															
445	446	447																																																																																																																																																																																																																																																																																																																																																																																																																																																																																																																																																																																																																																																																																																																																																																																																															
448	449	450																																																																																																																																																																																																																																																																																																																																																																																																																																																																																																																																																																																																																																																																																																																																																																																																															
451	452	453																																																																																																																																																																																																																																																																																																																																																																																																																																																																																																																																																																																																																																																																																																																																																																																																															
454	455	456																																																																																																																																																																																																																																																																																																																																																																																																																																																																																																																																																																																																																																																																																																																																																																																																															
457	458	459																																																																																																																																																																																																																																																																																																																																																																																																																																																																																																																																																																																																																																																																																																																																																																																																															
460	461	462																																																																																																																																																																																																																																																																																																																																																																																																																																																																																																																																																																																																																																																																																																																																																																																																															
463	464	465																																																																																																																																																																																																																																																																																																																																																																																																																																																																																																																																																																																																																																																																																																																																																																																																															
466	467	468																																																																																																																																																																																																																																																																																																																																																																																																																																																																																																																																																																																																																																																																																																																																																																																																															
469	470	471																																																																																																																																																																																																																																																																																																																																																																																																																																																																																																																																																																																																																																																																																																																																																																																																															
472	473	474																																																																																																																																																																																																																																																																																																																																																																																																																																																																																																																																																																																																																																																																																																																																																																																																															
475	476	477																																																																																																																																																																																																																																																																																																																																																																																																																																																																																																																																																																																																																																																																																																																																																																																																															
478	479	480																																																																																																																																																																																																																																																																																																																																																																																																																																																																																																																																																																																																																																																																																																																																																																																																															
481	482	483																																																																																																																																																																																																																																																																																																																																																																																																																																																																																																																																																																																																																																																																																																																																																																																																															
484	485	486																																																																																																																																																																																																																																																																																																																																																																																																																																																																																																																																																																																																																																																																																																																																																																																																															
487	488	489																																																																																																																																																																																																																																																																																																																																																																																																																																																																																																																																																																																																																																																																																																																																																																																																															
490	491	492																																																																																																																																																																																																																																																																																																																																																																																																																																																																																																																																																																																																																																																																																																																																																																																																															
493	494	495																																																																																																																																																																																																																																																																																																																																																																																																																																																																																																																																																																																																																																																																																																																																																																																																															
496	497	498																																																																																																																																																																																																																																																																																																																																																																																																																																																																																																																																																																																																																																																																																																																																																																																																															
499	500	501																																																																																																																																																																																																																																																																																																																																																																																																																																																																																																																																																																																																																																																																																																																																																																																																															
502	503	504																																																																																																																																																																																																																																																																																																																																																																																																																																																																																																																																																																																																																																																																																																																																																																																																															
505	506	507																																																																																																																																																																																																																																																																																																																																																																																																																																																																																																																																																																																																																																																																																																																																																																																																															
508	509	510																																																																																																																																																																																																																																																																																																																																																																																																																																																																																																																																																																																																																																																																																																																																																																																																															
511	512	513																																																																																																																																																																																																																																																																																																																																																																																																																																																																																																																																																																																																																																																																																																																																																																																																															
514	515	516																																																																																																																																																																																																																																																																																																																																																																																																																																																																																																																																																																																																																																																																																																																																																																																																															
517	518	519																																																																																																																																																																																																																																																																																																																																																																																																																																																																																																																																																																																																																																																																																																																																																																																																															
520	521	522																																																																																																																																																																																																																																																																																																																																																																																																																																																																																																																																																																																																																																																																																																																																																																																																															
523	524	525																																																																																																																																																																																																																																																																																																																																																																																																																																																																																																																																																																																																																																																																																																																																																																																																															
526	527	528																																																																																																																																																																																																																																																																																																																																																																																																																																																																																																																																																																																																																																																																																																																																																																																																															
529	530	531																																																																																																																																																																																																																																																																																																																																																																																																																																																																																																																																																																																																																																																																																																																																																																																																															
532	533	534																																																																																																																																																																																																																																																																																																																																																																																																																																																																																																																																																																																																																																																																																																																																																																																																															
535	536	537																																																																																																																																																																																																																																																																																																																																																																																																																																																																																																																																																																																																																																																																																																																																																																																																															
538	539	540																																																																																																																																																																																																																																																																																																																																																																																																																																																																																																																																																																																																																																																																																																																																																																																																															
541	542	543																																																																																																																																																																																																																																																																																																																																																																																																																																																																																																																																																																																																																																																																																																																																																																																																															
544	545	546																																																																																																																																																																																																																																																																																																																																																																																																																																																																																																																																																																																																																																																																																																																																																																																																															
547	548	549																																																																																																																																																																																																																																																																																																																																																																																																																																																																																																																																																																																																																																																																																																																																																																																																															
550	551	552																																																																																																																																																																																																																																																																																																																																																																																																																																																																																																																																																																																																																																																																																																																																																																																																															
553	554	555																																																																																																																																																																																																																																																																																																																																																																																																																																																																																																																																																																																																																																																																																																																																																																																																															
556	557	558																																																																																																																																																																																																																																																																																																																																																																																																																																																																																																																																																																																																																																																																																																																																																																																																															
559	560	561																																																																																																																																																																																																																																																																																																																																																																																																																																																																																																																																																																																																																																																																																																																																																																																																															
562	563	564																																																																																																																																																																																																																																																																																																																																																																																																																																																																																																																																																																																																																																																																																																																																																																																																															
565	566	567																																																																																																																																																																																																																																																																																																																																																																																																																																																																																																																																																																																																																																																																																																																																																																																																															
568	569	570																																																																																																																																																																																																																																																																																																																																																																																																																																																																																																																																																																																																																																																																																																																																																																																																															
571	572	573																																																																																																																																																																																																																																																																																																																																																																																																																																																																																																																																																																																																																																																																																																																																																																																																															
574	575	576																																																																																																																																																																																																																																																																																																																																																																																																																																																																																																																																																																																																																																																																																																																																																																																																															
577	578	579																																																																																																																																																																																																																																																																																																																																																																																																																																																																																																																																																																																																																																																																																																																																																																																																															
580	581	582																																																																																																																																																																																																																																																																																																																																																																																																																																																																																																																																																																																																																																																																																																																																																																																																															
583	584	585																																																																																																																																																																																																																																																																																																																																																																																																																																																																																																																																																																																																																																																																																																																																																																																																															
586	587	588																																																																																																																																																																																																																																																																																																																																																																																																																																																																																																																																																																																																																																																																																																																																																																																																															
589	590	591																																																																																																																																																																																																																																																																																																																																																																																																																																																																																																																																																																																																																																																																																																																																																																																																															
592	593	594																																																																																																																																																																																																																																																																																																																																																																																																																																																																																																																																																																																																																																																																																																																																																																																																															
595	596	597																																																																																																																																																																																																																																																																																																																																																																																																																																																																																																																																																																																																																																																																																																																																																																																																															
598	599	600																																																																																																																																																																																																																																																																																																																																																																																																																																																																																																																																																																																																																																																																																																																																																																																																															
601	602	603																																																																																																																																																																																																																																																																																																																																																																																																																																																																																																																																																																																																																																																																																																																																																																																																															
604	605	606																																																																																																																																																																																																																																																																																																																																																																																																																																																																																																																																																																																																																																																																																																																																																																																																															
607	608	609																																																																																																																																																																																																																																																																																																																																																																																																																																																																																																																																																																																																																																																																																																																																																																																																															
610	611	612																																																																																																																																																																																																																																																																																																																																																																																																																																																																																																																																																																																																																																																																																																																																																																																																															
613	614	615																																																																																																																																																																																																																																																																																																																																																																																																																																																																																																																																																																																																																																																																																																																																																																																																															
616	617	618																																																																																																																																																																																																																																																																																																																																																																																																																																																																																																																																																																																																																																																																																																																																																																																																															
619	620	621																																																																																																																																																																																																																																																																																																																																																																																																																																																																																																																																																																																																																																																																																																																																																																																																															
622	623	624																																																																																																																																																																																																																																																																																																																																																																																																																																																																																																																																																																																																																																																																																																																																																																																																															
625	626	627																																																																																																																																																																																																																																																																																																																																																																																																																																																																																																																																																																																																																																																																																																																																																																																																															
628	629	630																																																																																																																																																																																																																																																																																																																																																																																																																																																																																																																																																																																																																																																																																																																																																																																																															
631	632	633																																																																																																																																																																																																																																																																																																																																																																																																																																																																																																																																																																																																																																																																																																																																																																																																															
634	635	636																																																																																																																																																																																																																																																																																																																																																																																																																																																																																																																																																																																																																																																																																																																																																																																																															
637	638	639																																																																																																																																																																																																																																																																																																																																																																																																																																																																																																																																																																																																																																																																																																																																																																																																															
640	641	642																																																																																																																																																																																																																																																																																																																																																																																																																																																																																																																																																																																																																																																																																																																																																																																																															
643	644	645																																																																																																																																																																																																																																																																																																																																																																																																																																																																																																																																																																																																																																																																																																																																																																																																															
646	647	648																																																																																																																																																																																																																																																																																																																																																																																																																																																																																																																																																																																																																																																																																																																																																																																																															
649	650	651																																																																																																																																																																																																																																																																																																																																																																																																																																																																																																																																																																																																																																																																																																																																																																																																															
652	653	654																																																																																																																																																																																																																																																																																																																																																																																																																																																																																																																																																																																																																																																																																																																																																																																																															
655	656	657																																																																																																																																																																																																																																																																																																																																																																																																																																																																																																																																																																																																																																																																																																																																																																																																															
658	659	660																																																																																																																																																																																																																																																																																																																																																																																																																																																																																																																																																																																																																																																																																																																																																																																																															
661	662	663																																																																																																																																																																																																																																																																																																																																																																																																																																																																																																																																																																																																																																																																																																																																																																																																															
664	665	666																																																																																																																																																																																																																																																																																																																																																																																																																																																																																																																																																																																																																																																																																																																																																																																																															
667	668	669																																																																																																																																																																																																																																																																																																																																																																																																																																																																																																																																																																																																																																																																																																																																																																																																															
670	671	672																																																																																																																																																																																																																																																																																																																																																																																																																																																																																																																																																																																																																																																																																																																																																																																																															
673	674	675																																																																																																																																																																																																																																																																																																																																																																																																																																																																																																																																																																																																																																																																																																																																																																																																															
676	677	678																																																																																																																																																																																																																																																																																																																																																																																																																																																																																																																																																																																																																																																																																																																																																																																																															
679	680	681																																																																																																																																																																																																																																																																																																																																																																																																																																																																																																																																																																																																																																																																																																																																																																																																															
682	683	684																																																																																																																																																																																																																																																																																																																																																																																																																																																																																																																																																																																																																																																																																																																																																																																																															
685	686	687																																																																																																																																																																																																																																																																																																																																																																																																																																																																																																																																																																																																																																																																																																																																																																																																															
688	689	690																																																																																																																																																																																																																																																																																																																																																																																																																																																																																																																																																																																																																																																																																																																																																																																																															
691	692	693																																																																																																																																																																																																																																																																																																																																																																																																																																																																																																																																																																																																																																																																																																																																																																																																															
694	695	696																																																																																																																																																																																																																																																																																																																																																																																																																																																																																																																																																																																																																																																																																																																																																																																																															
697	698	699																																																																																																																																																																																																																																																																																																																																																																																																																																																																																																																																																																																																																																																																																																																																																																																																															
700	701	702																																																																																																																																																																																																																																																																																																																																																																																																																																																																																																																																																																																																																																																																																																																																																																																																															
703	704	705																																																																																																																																																																																																																																																																																																																																																																																																																																																																																																																																																																																																																																																																																																																																																																																																															
706	707	708																																																																																																																																																																																																																																																																																																																																																																																																																																																																																																																																																																																																																																																																																																																																																																																																															
709	710	711																																																																																																																																																																																																																																																																																																																																																																																																																																																																																																																																																																																																																																																																																																																																																																																																															
712	713	714																																																																																																																																																																																																																																																																																																																																																																																																																																																																																																																																																																																																																																																																																																																																																																																																															
715	716	717																																																																																																																																																																																																																																																																																																																																																																																																																																																																																																																																																																																																																																																																																																																																																																																																															
718	719	720																																																																																																																																																																																																																																																																																																																																																																																																																																																																																																																																																																																																																																																																																																																																																																																																															
721	722	723																																																																																																																																																																																																																																																																																																																																																																																																																																																																																																																																																																																																																																																																																																																																																																																																															
724	725	726																																																																																																																																																																																																																																																																																																																																																																																																																																																																																																																																																																																																																																																																																																																																																																																																															
727	728	729																																																																																																																																																																																																																																																																																																																																																																																																																																																																																																																																																																																																																																																																																																																																																																																																															
730	731	732																																																																																																																																																																																																																																																																																																																																																																																																																																																																																																																																																																																																																																																																																																																																																																																																															
733	734	735																																																																																																																																																																																																																																																																																																																																																																																																																																																																																																																																																																																																																																																																																																																																																																																																															
736	737	738																																																																																																																																																																																																																																																																																																																																																																																																																																																																																																																																																																																																																																																																																																																																																																																																															
739	740	741																																																																																																																																																																																																																																																																																																																																																																																																																																																																																																																																																																																																																																																																																																																																																																																																															
742	743	744																																																																																																																																																																																																																																																																																																																																																																																																																																																																																																																																																																																																																																																																																																																																																																																																															
745	746	747																																																																																																																																																																																																																																																																																																																																																																																																																																																																																																																																																																																																																																																																																																																																																																																																															
748	749	750																																																																																																																																																																																																																																																																																																																																																																																																																																																																																																																																																																																																																																																																																																																																																																																																															
751	752	753																																																																																																																																																																																																																																																																																																																																																																																																																																																																																																																																																																																																																																																																																																																																																																																																															
754	755	756																																																																																																																																																																																																																																																																																																																																																																																																																																																																																																																																																																																																																																																																																																																																																																																																															
757	758	759																																																																																																																																																																																																																																																																																																																																																																																																																																																																																																																																																																																																																																																																																																																																																																																																															
760	761	762																																																																																																																																																																																																																																																																																																																																																																																																																																																																																																																																																																																																																																																																																																																																																																																																															
763	764	765																																																																																																																																																																																																																																																																																																																																																																																																																																																																																																																																																																																																																																																																																																																																																																																																															
766	767	768																																																																																																																																																																																																																																																																																																																																																																																																																																																																																																																																																																																																																																																																																																																																																																																																															
769	770	771																																																																																																																																																																																																																																																																																																																																																																																																																																																																																																																																																																																																																																																																																																																																																																																																															
772	773	774																																																																																																																																																																																																																																																																																																																																																																																																																																																																																																																																																																																																																																																																																																																																																																																																															
775	776	777																																																																																																																																																																																																																																																																																																																																																																																																																																																																																																																																																																																																																																																																																																																																																																																																															
778	779	780																																																																																																																																																																																																																																																																																																																																																																																																																																																																																																																																																																																																																																																																																																																																																																																																															
781	782																																																																																																																																																																																																																																																																																																																																																																																																																																																																																																																																																																																																																																																																																																																																																																																																																

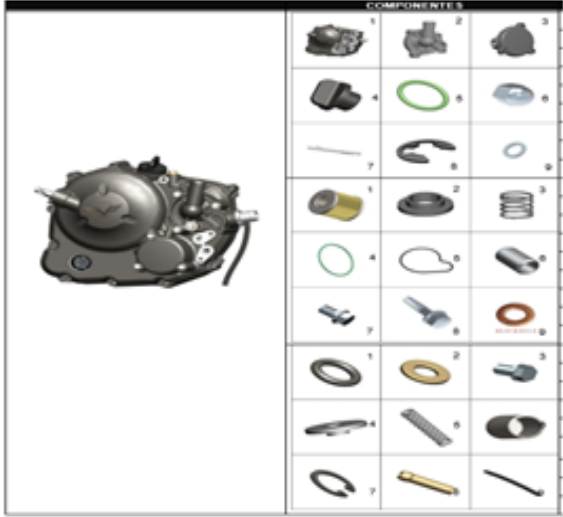
INDICE GRAFICOS

			
<p>FIGURA N° 115: CUBIERTA CARCA SA MOTOR IZQUIERDA</p>	<p>PÁ G.N°.69</p>	<p>FIGURA N° 116: TAPA PIÑON REDUCTOR ARRANQUE</p>	<p>PÁ G.N°.69</p>
			
<p>FIGURA N° 118: TAPA CARTER DERECHA</p>	<p>PÁ G.N°.71</p>	<p>FIGURA N° 119: CUBIERTA CARCA SA MOTOR DERECHA</p>	<p>PÁ G.N°.72</p>
<p>FIGURA N° 120: MOTOR DE ARRANQUE</p>	<p>PÁ G.N°.73</p>	<p>FIGURA N° 117: TAPA CARTER DERECHA</p>	<p>PÁ G.N°.70</p>

INDICE GRAFICOS

	<p>COMPONENTES</p> <table border="1"> <tr> <td>1</td> <td>2</td> <td>3</td> </tr> <tr> <td>4</td> <td>5</td> <td>6</td> </tr> <tr> <td>7</td> <td>8</td> <td>9</td> </tr> <tr> <td>1</td> <td>2</td> <td>3</td> </tr> <tr> <td>4</td> <td>5</td> <td>6</td> </tr> <tr> <td>7</td> <td>8</td> <td>9</td> </tr> </table>	1	2	3	4	5	6	7	8	9	1	2	3	4	5	6	7	8	9		
1	2	3																			
4	5	6																			
7	8	9																			
1	2	3																			
4	5	6																			
7	8	9																			
<p>FIGURA N° 121: CADENILLA DE DISTRIBUCIÓN</p>	<p>PÁG.N° 74</p>																				

FIGURA 1: VELOCIMETRO

				COMPONENTES	ÍTEM	REFERENCIA	COD. SAP	DESCRIPCIÓN	CANTIDAD
	1	2	3	1	1164300-003000	11084746	VELOCIMETRO	1	
				2	1250301-020093	11072003	TUERCA M6	3	
				3	1250502-010093	11071994	ARANDELA (D6)	3	
	4	5	6	4	1244200-092000	11072423	CAUCHO GOMA	3	
				5	1274200-169000	11073061	SOPORTE INFERIOR VELOCÍMETRO	1	
				6	1250205-006091	11072968	PERNO ALLEN M8X45	1	
	7	8	9	7	1250501-007093	11071979	ARANDELA (D8)	1	
				8	1251300-063093	11072320	CHAPETA M6 X 11 X 15	1	
				9					

FIGURA 2: CUBIERTA INFERIOR VELOCÍMETRO

				COMPONENTES	ÍTEM	REFERENCIA	COD. SAP	DESCRIPCIÓN	CANTIDAD
	1	2	3	1	1224200-128000	11072869	CUBIERTA INFERIOR VELOCÍMETRO	1	
				2	1244100-052000	11071842	BUJE DE GOMA (D8.5 X D14 X 1)	1	
				3	1274100-057095	11072005	BUJE D6.2X8.4X3.5+14X1.5	1	
	4	5	6	4	1251100-102000	11071837	PERNO M6 X 16 (CUADRANTE ALLEN)	1	
				5					
				6					
	7	8	9	7					
				8					
				9					

FIGURA 3: CUBEIRTA FAROLA

	COMPONENTES			ÍTEM	REFERENCIA	COD. SAP	DESCRIPCIÓN	CANTIDAD
	1	2	3	1	1020442-005000	11075709	ZT350R CUB SUPERIOR FAROLA SIN PINT	1
				2	1020442-001000	11075710	ZT350R CUBIE CENTRAL FAROLA SIN PINT	1
				3	1020443-029000	11075712	ZT350R CUBIERTA FAROLA IZQ SIN PINT	1
	4	5	6	4	1020443-028000	11075713	ZT350R CUBIERTA FAROLA DER SIN PINT	1
				5	1244200-005000	11072805	ANTIVIBRANTE	4
				6	1251300-063093	11072320	CHAPETA M6 X 11 X 15	1
	7	8	9	7	1244100-052000	11071842	BUJE DE GOMA (D8.5 X D14 X 1)	2
				8	1274100-057095	11072005	BUJE D6.2X8.4X3.5+14X1.5	2
				9	1251100-102000	11071837	PERNO M6 X 16 (CUADRANT ALLEN)	2
	10			10	1240300-021000	11072217	TIRA DE CAUCHO DE VIDRIO	0.17

FIGURA 4: FAROLA

	COMPONENTES			ÍTEM	REFERENCIA	COD. SAP	DESCRIPCIÓN	CANTIDAD
	1	2	3	1	1174300-001000	11072907	FAROLA	1
				2	1251300-063093	11072320	CHAPETA M6 X 11 X 15	2
				3	1244100-052000	11071842	BUJE DE GOMA (D8.5 X D14 X 1)	1
	4	5	6	4	1274100-057095	11072005	BUJE D6.2X8.4X3.5+14X1.5	1
				5	1251100-102000	11071837	PERNO M6 X 16 (CUADRANTE ALLEN)	1
				6				
	7	8	9	7				
				8				
				9				

FIGURA 5: SOPORTE SUPERIOR FAROLA

		COMPONENTES			ÍTEM	REFERENCIA	COD. SAP	DESCRIPCIÓN	CANTIDAD
				1	1274200-006000	11072044	SOPORTE SUPERIOR IZQU FAROLA	1	
				2	1274300-107000	11075315	PLATINA SUPERIOR FAROLA	1	
				3	1250205-040095	11072023	PERNO HEXAGONAL M8 X 16	2	
				4	1240400-007000	11072072	BUJE DE GOMA SOPOR DE BATERÍA	2	
				5	1251700-059093	11071845	BUJE D6.4X9X8+ 18X2	2	
				6	1251100-102000	11071837	PERNO M6 X 16 (CUADRANTE ALLEN)	2	
				7	1224300-110000	11075397	ABRAZADERA VELCRO 20X200MM	2	
				8	1224300-111000	11075524	ABRAZADERA VELCRO 20X300MM	1	
				9					

FIGURA 6: CUBIERTA CABLEADO FAROLA

		COMPONENTES			ÍTEM	REFERENCIA	COD. SAP	DESCRIPCIÓN	CANTIDAD
				1	1224200-007000	11072866	CUBIERTA CABLEADO FAROLA	1	
				2	1224300-085000	11075389	GUIA CABLES PLASTICA	3	
				3	1274200-007000	11072147	SOPORTE INFERIOR FAROLA	1	
				4	1240400-007000	11072072	BUJE DE GOMA SOPORT DE BATERÍA	2	
				5	1274200-024000	11071860	PIN AJUSTE FAROLA	2	
				6	1264100-006000	11072237	PIN DE SEGURIDAD DEL PEDAL	2	
				7	1244100-052000	11071842	BUJE DE GOMA (D8.5 X D14 X 1)	2	
				8	1274100-057095	11072005	BUJE D6.2X8.4X3.5+14X1.5	2	
				9	1251100-102000	11071837	PERNO M6 X 16 (CUADRANTE ALLEN)	5	

FIGURA 7: CUBIERTA MOTOR IZQUIERDA

				COMPONENTES	ÍTEM	REFERENCIA	COD. SAP	DESCRIPCIÓN	CANTIDAD
	1	2	3	1	1020442-008000	11075715	ZT350R CUBIERTA MOTOR IZQ SIN PINT	1	
				2	1224300-006000	11075310	REJILLA FRONTAL INFERIOR	1	
				3	1020441-020000	11075708	ZT350R CUBIERTA MOTOR DER SIN PINT	1	
	4	5	6	4	1251100-102000	11071837	PERNO M6 X 16 (CUADRANTE ALLEN)	7	
				5	1251300-063093	11072320	CHAPETA M6 X 11 X 15	4	
				6	1274100-007000	11072214	BUJE (6.4X9X6+20X2)	3	
	7	8	9	7	1244100-004000	11072027	ANTIVIBRANTE AMORTIGUADOR	3	
				8	1274100-057095	11072005	BUJE D6.2X8.4X3.5+14X1.5	4	
				9	1244100-052000	11071842	BUJE DE GOMA (D8.5 X D14 X 1)	4	

FIGURA 8: SOPORTES CUBIERTA

				COMPONENTES	ÍTEM	REFERENCIA	COD. SAP	DESCRIPCIÓN	CANTIDAD
	1	2	3	1	1274300-006000	11075316	PLATINA CUBIERTA INF DER	1	
				2	1251112-005093	11072244	PERNO CON BRIDA M6 X 75	1	
				3	1274300-005000	11075317	PLATINA CUBIERTA INF IZQ	1	
	4	5	6	4	1251112-003093	11071982	PERNO HEXAGONAL M6 X 45	1	
				5					
				6					
				7					
				8					
				9					

FIGURA 9: TANQUE DE COMBUSTIBLE

	COMPONENTES			ÍTEM	REFERENCIA	COD. SAP	DESCRIPCIÓN	CANTIDAD
		1	2	3	1	4034200-024000	11079691	TANQUE DE COMBUSTIBLE
				2	1224100-033000	11072033	TAPÓN TANQUE DE COMBUSTIBLE	1
				3	1240300-021000	11072217	TIRA DE CAUCHO DE VIDRIO	1
4		5	6	4	1244100-002000	11072295	BUJE DE GOMA CUBIERTA LATERAL	4
				5	1050958-011000	11075313	BOMBA DE COMBUSTIBLE	1
				6	1050954-006000	11072934	MANGUERA ALTA PRESIÓN COMBUSTIBLE	1
7		8	9	7	1250105-137093	11071980	PERNO HEXAGONAL M6 X 16	8
				8	1224200-066000	11072669	SOPORTE ANTENA EXTERNA	1
				9				

FIGURA 10: SOPORTE TANQUE DE COMBUSTIBLE

	COMPONENTES			ÍTEM	REFERENCIA	COD. SAP	DESCRIPCIÓN	CANTIDAD
		1	2	3	1	1250205-043093	11072565	PERNO M8 55
				2	1251900-028093	11072822	ARANDELA D9XD37.5X2	2
				3	1244100-020000	11072001	ANTIVIBRANTE TANQUE	2
4		5	6	4	1244100-053000	11071983	EMPAQUE TANQUE DE COMBUSTIBLE	2
				5	1274100-080000	11075381	SOPOR TRAS TANQUE COMBUSTIBLE	1
				6				
7		8	9	7				
				8				
				9				

FIGURA 11: SOPORTES

				COMPONENTES	ÍTEM	REFERENCIA	COD. SAP	DESCRIPCIÓN	CANTIDAD
	 1	 2	 3	1	1274200-013000	11084747	SOPORTE FRONTAL	1	
				2	1274200-014000	11084748	SOPORTE TRASERO	1	
				3	1251100-101000	11071836	PERNO M6 X 12 (CUADRANTE ALLEN)	4	
	 4	 5	 6	4					
				5					
				6					
	 7	 8	 9	7					
				8					
				9					

FIGURA 12: CUBIERTA TANQUE IZQUIERDO

				COMPONENTES	ÍTEM	REFERENCIA	COD. SAP	DESCRIPCIÓN	CANTIDAD
	 1	 2	 3	1	1020443-043000	11075719	ZT350R CUBIE TANQUE IZQ SIN PINT	1	
				2	1020442-011000	11072870	ZT350R/350T COMP TANQ IZQ SIN PIN	1	
				3	1251300-063093	11072320	CHAPETA M6 X 11 X 15	7	
	 4	 5	 6	4	1244100-002000	11072295	BUJE DE GOMA CUBIERTA LATERAL	1	
				5	1274100-007000	11072214	BUJE (6.4X9X6+20X2)	4	
				6	1244100-004000	11072027	ANTIVIBRANTE AMORTIGUADOR	4	
	 7	 8	 9	7	1244100-052000	11071842	BUJE DE GOMA (D8.5 X D14 X 1)	3	
				8	1274100-057095	11072005	BUJE D6.2X8.4X3.5+14X1.5	3	
				9	1251100-102000	11071837	PERNO M6 X 16 (CUADRANTE ALLEN)	7	

FIGURA 13: CUBIERTA TANQUE DERECHA

		COMPONENTES			ÍTEM	REFERENCIA	COD. SAP	DESCRIPCIÓN	CANTIDAD
	1	2	3	1	1020443-045000	11075718	ZT350R CUBIERTA TANQUE DER SIN PINT	1	
				2	1020443-049000	11075314	ZT350R/350T COMPL TANQUE DER SIN PINT	1	
				3	1251300-063093	11072320	CHAPETA M6 X 11 X 15	7	
	4	5	6	4	1244100-002000	11072295	BUJE DE GOMA CUBIERTA LATERAL	1	
				5	1274100-007000	11072214	BUJE (6.4X9X6+20X2)	4	
				6	1244100-004000	11072027	ANTIVIBRANTE AMORTIGUADOR	4	
	7	8	9	7	1244100-052000	11071842	BUJE DE GOMA (D8.5 X D14 X 1)	3	
				8	1274100-057095	11072005	BUJE D6.2X8.4X3.5+14X1.5	3	
				9	1251100-102000	11071837	PERNO M6 X 16 (CUADRANTE ALLEN)	7	

FIGURA 14: CUBIERTA CENTRAL TANQUE

		COMPONENTES			ÍTEM	REFERENCIA	COD. SAP	DESCRIPCIÓN	CANTIDAD
	1	2	3	1	1020442-014000	11075716	ZT350R CUBI CENTRAL TANQUE SIN PINT	1	
				2	1184200-002000	11072047	CERRADURA ELECTRÓNICA DEPÓSITO COMB	1	
				3	1274100-021000	11075835	SOPORTE GIRATORIO TAPA COMBUSTIBLE	1	
	4	5	6	4	1260100-215000	11072239	PIN DE SEGURIDAD	1	
				5	1274100-090000	11072053	EJE GIRATORIO CUBIERTA DEPÓSITO	1	
				6	1224100-014000	11072138	ANTIVIBRANTE CUBIERTA TANQUE	1	
	7	8	9	7	1020442-015000	11075717	ZT350R COMPL CUB CENTR TANQ SIN PINT	1	
				8	1224100-010000	11071843	REMACHE PLÁSTICO	4	
				9	1251100-102000	11071837	PERNO M6 X 16 (CUADRANTE ALLEN)	2	

FIGURA 15: CUBIERTAS LATERALES

				ÍTEM	REFERENCIA	COD. SAP	DESCRIPCIÓN	CANTIDAD
	COMPONENTES							
	1	2	3	1	1020442-016000	11074235	ZT CUB LATERAL LH SIN PINT 350T1/350R	1
				2	1020442-017000	11074234	ZT CUB LATERAL RH SIN PINT 350T1/350R	1
				3	1224100-010000	11071843	REMACHE PLÁSTICO	2
	4	5	6	4				
				5				
				6				
	7	8	9	7				
				8				
			9					

FIGURA 16: CUBIERTAS LATERALES











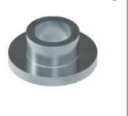

COMPONENTES			ÍTEM	REFERENCIA	COD. SAP	DESCRIPCIÓN	CANTIDAD	
				1	1224300-090000	11075311	CUBIERTA LATERAL IZQ	1
				2	1224300-091000	11075312	CUBIERTA LATERAL DER	1
				3	1251300-063093	11072320	CHAPETA M6 X 11 X 15	2
				4	1244100-052000	11071842	BUJE DE GOMA (D8.5 X D14 X 1)	12
				5	1274100-057095	11072005	BUJE D6.2X8.4X3.5+14X1.5	12
				6	1251100-102000	11071837	PERNO M6 X 16 (CUADRANT ALLEN)	12
				7	1184200-100000	11072254	CARGADOR USB	1
				8	1244100-015000	11071864	RETÉN DE GOMA PARA TUERCA DE AJUSTE	1
				9	1251500-081000	11072820	ARANDELA D13XD8.2X1.5	2
				1	1224200-066000	11072669	SOPORTEANTENA EXTERNA	1
				2	1224300-083000	11075338	PLATINA DER CABLEADO	1
				3	1224300-084000	11075339	PLATINA IZQ CABLEADO	1
				4	1274100-018000	11071984	BUJE	1
				5				
				6				
				7				
				8				

FIGURA 17: DIRECCIONALES DELANTERAS

COMPONENTES			ÍTEM	REFERENCIA	COD. SAP	DESCRIPCIÓN	CANTIDAD	
	1	2	3	1	1174200-004000	11072878	DIRECCIONAL DELANTERA IZQ	1
				2	1174200-005000	11072877	DIRECCIONAL DELANTERA DERECHA	1
				3	1244100-052000	11071842	BUJE DE GOMA (D8.5 X D14 X 1)	4
	4	5	6	4	1274100-057095	11072005	BUJE D6.2X8.4X3.5+14X1.5	4
				5	1251100-102000	11071837	PERNO M6 X 16 (CUADRANTE ALLEN)	2
				6	1250303-010093	11072127	TUERCA M6	2
	7	8	9	7	1251100-061093	11071976	PERNO HEX CON BRIDA M6 X 22	2
				8				
				9				

FIGURA 18: ENFOCADORES

COMPONENTES			ÍTEM	REFERENCIA	COD. SAP	DESCRIPCIÓN	CANTIDAD	
	1	2	3	1	1020442-006000	11074229	ZT ENFOCADOR LH SIN PINT 350T1/350R	1
				2	1020442-004000	11074228	ZT ENFOCADOR RH SIN PINT 350T1/350R	1
				3	1224100-010000	11071843	REMACHE PLÁSTICO	2
	4	5	6	4	1251300-063093	11072320	CHAPETA M6 X 11 X 15	6
				5				
				6				
	7	8	9	7				
				8				
				9				

FIGURA 19: CAJA DISPOSITIVOS ELECTRICOS

COMPONENTES			ÍTEM	REFERENCIA	COD. SAP	DESCRIPCIÓN	CANTIDAD	
				1	1224200-161000	11075417	CAJA DISPOSITIVOS ELÉCTRICOS	1
				2	1251300-063093	11072320	CHAPETA M6 X 11 X 15	6
				3	1251100-102000	11071837	PERNO M6 X 16 (CUADRANT ALLEN)	2
				4	1251513-001019	11071896	ARANDELA DE COBRE 6.3X12X1.6	1
				5	1251100-101000	11071836	PERNO M6 X 12 (CUADRANT ALLEN)	4
				6	1184100-010000	11072142	RELÉ DE ARRANQUE	1
				7	1240300-007000	11072223	ANTIVIBRANTE BATERÍA	3
				8	1050958-014000	11075390	ECU	1
				9	1224200-176000	11075420	TAPA BATERÍA	1
				1	1224200-040000	11071883	CUBIER INF CAJA PIEZAS ELÉCTRIC	1
				2	1274300-017000	11075376	PLATINA PUERTO DE CARGA	1
				3	1251200-050094	11072685	TORNILLO 3.9 X 12	1
				4	1184300-040000	11084749	SOPORTE DEL PUERTO DE CARGA	1
				5	1184100-002000	11071886	SENSOR DE VUELCO	1
				6	1244100-082000	11072022	SOP DE GOMA PARA SENS DE VUEL	1
				7				
				8				

FIGURA 20: BATERÍA

COMPONENTES			ÍTEM	REFERENCIA	COD. SAP	DESCRIPCIÓN	CANTIDAD	
	 <p>1</p>	 <p>2</p>	 <p>3</p>	1	1184200-099000	11073094	BATERÍA GEL 6-FM-10/10AH	1
				2	1244200-111000	11072434	CORREA BATERÍA	1
				3	1184300-037000	11075918	CARGADOR DE BATERÍAS	1
	 <p>4</p>	5	6	4	1274300-087000	11084702	HERRAMIENTA	1
				5				
				6				
				7				
				8				
				9				

FIGURA 21: SOPORTE BATERÍA

COMPONENTES			ÍTEM	REFERENCIA	COD. SAP	DESCRIPCIÓN	CANTIDAD	
	 <p>1</p>	 <p>2</p>	 <p>3</p>	1	1274200-238000	11073058	SOPORTE BATERÍA	1
				2	1251100-101000	11071836	PERNO M6 X 12 (CUADRANTE ALLEN)	3
				3	1274100-057095	11072005	BUJE D6.2X8.4X3.5+14X1.5	1
	 <p>4</p>	 <p>5</p>	 <p>6</p>	4	1244100-052000	11071842	BUJE DE GOMA (D8.5 X D14 X 1)	1
				5	1250303-010093	11072127	TUERCA M6	2
				6	1240300-007000	11072223	ANTIVIBRANTE BATERÍA	2
				7				
				8				
				9				

FIGURA 22: CUBIERTA IZQUIERDA SILLÍN

	COMPONENTES			ÍTEM	REFERENCIA	COD. SAP	DESCRIPCIÓN	CANTIDAD
		 <p>1</p>	 <p>2</p>	 <p>3</p>	1	1020442-112000	11075706	ZT350R COMPL CUB SILLIN IZQ SIN PINT
2					1250105-142093	11072978	PERNO HEX M8X20	1
3					1251700-058093	11072180	BUJE D8.2 X D11 X 4.5 + D16 X 1.5	1
 <p>4</p>		 <p>5</p>	 <p>6</p>	4	1240300-071000	11071835	BUJE DE GOMA (D11 X D16 X 1)	1
				5	1251100-102000	11071837	PERNO M6 X 16 (CUADRANTE ALLEN)	1
				6	1251100-101000	11071836	PERNO M6 X 12 (CUADRANTE ALLEN)	1
 <p>7</p>		 <p>8</p>	 <p>9</p>	7	1244100-052000	11071842	BUJE DE GOMA (D8.5 X D14 X 1)	2
				8	1274100-018000	11071984	BUJE	1
				9	1274100-057095	11072005	BUJE D6.2X8.4X3.5+14X1.5	1

FIGURA 23: CUBIERTA DERECHA SILLÍN

	COMPONENTES			ÍTEM	REFERENCIA	COD. SAP	DESCRIPCIÓN	CANTIDAD
		 <p>1</p>	 <p>2</p>	 <p>3</p>	1	1020442-113000	11075707	ZT350R COMPL CUB SILLIN DER SIN PINT
2					1250105-142093	11072978	PERNO HEX M8X20	1
3					1251700-058093	11072180	BUJE D8.2 X D11 X 4.5 + D16 X 1.5	1
 <p>4</p>		 <p>5</p>	 <p>6</p>	4	1240300-071000	11071835	BUJE DE GOMA (D11 X D16 X 1)	1
				5	1251100-102000	11071837	PERNO M6 X 16 (CUADRANTE ALLEN)	1
				6	1251100-101000	11071836	PERNO M6 X 12 (CUADRANTE ALLEN)	1
 <p>7</p>		 <p>8</p>	 <p>9</p>	7	1244100-052000	11071842	BUJE DE GOMA (D8.5 X D14 X 1)	2
				8	1274100-018000	11071984	BUJE	1
				9	1274100-057095	11072005	BUJE D6.2X8.4X3.5+14X1.5	1

FIGURA 24: CUBIERTAS LATERALES INTERIORES

		COMPONENTES			ÍTEM	REFERENCIA	COD. SAP	DESCRIPCIÓN	CANTIDAD
				1	1224200-095000	11075330	CUBIERTA LAT INT TRAS IZQ	1	
				2	1224200-096000	11075331	CUBIERTA LAT INT TRAS DER	1	
				3	1224100-010000	11071843	REMACHE PLÁSTICO	2	
				4	1251300-063093	11072320	CHAPETA M6 X 11 X 15	2	
				5	1251200-033093	11071844	PERNO 4.2 X 12 (CUADRANTE ALLEN)	2	
				6	1244100-052000	11071842	BUJE DE GOMA (D8.5 X D14 X 1)	2	
				7	1274100-057095	11072005	BUJE D6.2X8.4X3.5+14X1.5	2	
				8	1251100-102000	11071837	PERNO M6 X 16 (CUADRANTE ALLEN)	2	
				9					

FIGURA 25: CUBIERTA INFERIOR SILLÍN

		COMPONENTES			ÍTEM	REFERENCIA	COD. SAP	DESCRIPCIÓN	CANTIDAD
				1	1020442-111000	11075711	ZT350R CUBIERTA SILLIN INF SIN PINT	1	
				2	1244100-002000	11072295	BUJE DE GOMA CUBIERTA LATERAL	4	
				3	1244100-052000	11071842	BUJE DE GOMA (D8.5 X D14 X 1)	2	
				4	1274100-057095	11072005	BUJE D6.2X8.4X3.5+14X1.5	2	
				5	1251100-102000	11071837	PERNO M6 X 16 (CUADRANTE ALLEN)	8	
				6	1251100-101000	11071836	PERNO M6 X 12 (CUADRANTE ALLEN)	2	
				7	1251300-063093	11072320	CHAPETA M6 X 11 X 15	2	
				8	1224100-010000	11071843	REMACHE PLÁSTICO	2	
				9					

FIGURA 26: STOP TRASERO

	COMPONENTES			ÍTEM	REFERENCIA	COD. SAP	DESCRIPCIÓN	CANTIDAD
		1	2	3	1	1174200-014000	11075332	STOP TRASERO
				2	1174200-012000	11075325	STOP TRASERO IZQUIERDO	1
				3	1224200-054000	11075326	CUBIERTA IZQ STOP	1
4		5	6	4	1174200-013000	11075327	STOP TRASERO DERECHO	1
				5	1224200-056000	11075328	CUBIERTA DER STOP	1
				6	1251300-063093	11072320	CHAPETA M6 X 11 X 15	4
7		8	9	7				
				8				
				9				

FIGURA 27: SOPORTE STOP TRASERO

	COMPONENTES			ÍTEM	REFERENCIA	COD. SAP	DESCRIPCIÓN	CANTIDAD
		1	2	3	1	1274200-017000	11075335	SOPORTE STOP TRASERO
				2	1251100-102000	11071837	PERNO M6 X 16 (CUADRANTE ALLEN)	3
				3	1274100-057095	11072005	BUJE D6.2X8.4X3.5+14X1.5	1
4		5	6	4	1244100-052000	11071842	BUJE DE GOMA (D8.5 X D14 X 1)	1
				5				
				6				
7		8	9	7				
				8				
				9				

FIGURA 28: SOPORTE GUARDABARRO TRASERO

	COMPONENTES			ÍTEM	REFERENCIA	COD. SAP	DESCRIPCIÓN	CANTIDAD
					1	1020242-265021	11073060	SOPORTE GUARDABARRO TRASER
				2	1250503-006091	11072372	ARANDELA (D10)	2
				3	1250501-004091	11072836	BUJE	2
				4	1251100-117093	11071921	PERNOS M8 X 25 (CUADRANT ALLEN)	2
				5				
				6				
				7				
				8				
				9				

FIGURA 29: SOPORTE GUARDABARRO TRASERO

	COMPONENTES			ÍTEM	REFERENCIA	COD. SAP	DESCRIPCIÓN	CANTIDAD
					1	4024200-101000	11073005	PLATINA AUXILIAR TRASERA
				2	4024200-036000	11075337	SOPORTE AUX GUARDABARRO TRAS	1
				3	1251100-101000	11071836	PERNO M6 X 12 (CUADRANTE ALLEN)	4
				4	1250105-137093	11071980	PERNO HEXAGONAL M6 X 16	4
				5	1274100-057095	11072005	BUJE D6.2X8.4X3.5+14X1.5	3
				6	1244100-052000	11071842	BUJE DE GOMA (D8.5 X D14 X 1)	3
				7	1250501-007093	11071979	ARANDELA (D8)	5
				8	1224200-106000	11075341	PLATINA AUX GUARDABA TRASERO	1
				9	1251100-102000	11071837	PERNO M6 X 16 (CUADRANTE ALLEN)	4

FIGURA 30: GUARDABARRO TRASERO

	COMPONENTES			ÍTEM	REFERENCIA	COD. SAP	DESCRIPCIÓN	CANTIDAD
		1	2	3	1	1224200-091000	11072915	GUARDABARRO TRASERO INF
				2	1251300-063093	11072320	CHAPETA M6 X 11 X 15	4
				3	1244100-052000	11071842	BUJE DE GOMA (D8.5 X D14 X 1)	4
4		5	6	4	1274100-057095	11072005	BUJE D6.2X8.4X3.5+14X1.5	4
				5	1251100-102000	11071837	PERNO M6 X 16 (CUADRANTE ALLEN)	4
				6	1174100-002000	11071834	REFLECTIVO ROJO	1
7		8	9	7	1244100-006000	11071841	ANTIVIBRANTE PLACA	1
				8	1270300-273000	11072076	ABRAZADERA RAMAL	1
				9	1244200-082000	11072808	ANTIVIBRANTE PLACA	1

FIGURA 31: SOPORTE DIRECCIONALES COMPLETO

	COMPONENTES			ÍTEM	REFERENCIA	COD. SAP	DESCRIPCIÓN	CANTIDAD
		1	2	3	1	1174200-035000	11075843	SOPOR DIRECCIONALES COMPLETO
				2	1251300-063093	11072320	CHAPETA M6 X 11 X 15	2
				3	1251100-102000	11071837	PERNO M6 X 16 (CUADRANTE ALLEN)	4
4		5	6	4	1250502-010093	11071994	ARANDELA (D6)	2
				5	1274100-057095	11072005	BUJE D6.2X8.4X3.5+14X1.5	2
				6	1244100-052000	11071842	BUJE DE GOMA (D8.5 X D14 X 1)	4
7		8	9	7	1274100-018000	11071984	BUJE	2
				8				
				9				

FIGURA 32: SOPORTE DIRECCIONALES TRASERAS

				COMPONENTES	ÍTEM	REFERENCIA	COD. SAP	DESCRIPCIÓN	CANTIDAD
	1	2	3	1	1224200-120000	11073059	SOPOR DIRECCIONALES TRASERAS	1	
	2			2	1174200-019000	11072880	DIRECCIONAL TRASERA IZQUIERDA	1	
	3			3	1174200-020000	11072879	DIRECCIONAL TRASERA DERECHA	1	
	4	5	6	4	1174200-021000	11072932	LUZ PLACA	1	
				5					
				6					
	7	8	9	7					
				8					
				9					

FIGURA 33: RAMAL GUARDABARRO TRASERO

				COMPONENTES	ÍTEM	REFERENCIA	COD. SAP	DESCRIPCIÓN	CANTIDAD
	1	2	3	1	1184200-030000	11075329	RAMAL GUARDABARRO TRASERO	1	
	2			2	1274200-119000	11075841	SOPORTE LÍNEA COMBUSTIBLE	4	
	3			3	1250104-006097	11071992	PERNO HEXAGONAL M6 X 12	4	
	4	5	6	4	1251100-122093	11072965	PERNO ALLEN M8X16	4	
				5	1251700-058093	11072180	BUJE D8.2 X D11 X 4.5 + D16 X 1.5	4	
				6	1240300-071000	11071835	BUJE DE GOMA (D11 X D16 X 1)	4	
	7	8	9	7	1020442-021000			1	
				8					
				9					

FIGURA 34: SOPORTE PLACA

	COMPONENTES			ÍTEM	REFERENCIA	COD. SAP	DESCRIPCIÓN	CANTIDAD
		1	2	3	1	1270300-039000	11072258	SOPORTE PLACA
				2	1251100-101000	11071836	PERNO M6 X 12 (CUADRANTE ALLEN)	2
				3	1250303-010093	11072127	TUERCA M6	2
4		5	6	4	1250503-021093	11071995	ARANDELA (D8)	2
				5				
				6				
7		8	9	7				
				8				
				9				

FIGURA 35: PORTA PLACA

	COMPONENTES			ÍTEM	REFERENCIA	COD. SAP	DESCRIPCIÓN	CANTIDAD
		1	2	3	1	1210201-362000	11084698	PORTA PLACA
				2	1251100-101000	11071836	PERNO M6 X 12 (CUADRANTE ALLEN)	2
				3	1250303-010093	11072127	TUERCA M6	2
4		5	6	4				
				5				
				6				
7		8	9	7				
				8				
				9				

FIGURA 36: SILLÍN

				COMPONENTES	ÍTEM	REFERENCIA	COD. SAP	DESCRIPCIÓN	CANTIDAD
	1	2	3	1	4120100-006000	11079690	SILLIN	1	
				2	1244100-024000	11071848	ANTIVIBRANTE DE GOMA	2	
				3	1244300-033000	11071940	ANTIVIBRANTE	4	
	4	5	6	4	1244100-025000	11071849	ANTIVIBRANTE REDONDO SILLÍN	4	
				5	1010502-005000	11072231	CORREA DE SEGURIDAD	1	
				6	1250303-010093	11072127	TUERCA M6	2	
	7	8	9	7					
				8					
				9					

FIGURA 37: MAUBRIO

				COMPONENTES	ÍTEM	REFERENCIA	COD. SAP	DESCRIPCIÓN	CANTIDAD
	1	2	3	1	1134300-017051	11075388	MANUBRIO	1	
				2	1184200-184000	11072317	COMANDO IZQUIERDO	1	
				3	1244100-041000	11072055	MANILLAR IZQUIERDO	1	
	4	5	6	4	1134300-018000	11075393	PESA MANUBRIO	2	
				5	1154300-004000	11075491	CABLE DE ACELERADOR	1	
				6	1154300-005000	11075492	CABLE RETORNO ACELERADOR	1	
	7	8	9	7	1274300-105000	11079476	TORNILLO M5X25	1	
				8					
				9					
	1	2	3	1	1184200-185000	11072862	COMANDO DERECHO	1	
				2	1244100-042000	11072245	MANILLAR DERECHO	1	
				3	1244300-042000	11075879	ABRAZADERA GOMA	2	
	4	5	6	4	1274300-104000	11073073	TORNILLO M5X28	1	
				5					
				6					
7	8	9	7						
			8						

FIGURA 38: LEVA DE CLUTCH

	COMPONENTES			ÍTEM	REFERENCIA	COD. SAP	DESCRIPCIÓN	CANTIDAD
					1	1134200-029051	11075308	SOPORTE LEVA CLUTCH
				2	1134200-027051	11072930	LEVA DE CLUTCH	1
				3	1251100-198000	11072051	PERNO HEXAGON M6 X 13 – D8 X 20	1
				4	1251300-073000	11072074	TUERCA HEXAGONAL M6	1
				5	1184200-170000	11071970	SWITCH CLUTCH	1
				6	1250201-039000	11071969	TORNILLO PHILLIPS M4 X 12	1
				7	1244200-046000	11072052	FUNDA CABLE CLUTCH	1
				8	1190100-408051	11072492	ESPEJO RETROVISOR IZQUIERDO	1
				9	1154300-001000	11075309	CABLE DE CLUTCH	1
				1	1184300-019000	11072861	COMANDO AUX IZQ (SET-MODE)	1
				2	1250205-031091	11072243	TORNILLO M6 X 30	2
				3				
				4				
				5				
				6				
				7				
				8				

FIGURA 39: SOPORTE MANUBRIO

	COMPONENTES			ÍTEM	REFERENCIA	COD. SAP	DESCRIPCIÓN	CANTIDAD
		1	2	3	1	1134300-012000	11075319	SOPORTE SUPERIOR MANUBRIO
				2	4044102-001051	11071898	HEBILLA DECORATIVA DE PERNO M8	4
				3	1250205-023000	11072024	PERNO M8 X 35	4
4		5	6	4	4094300-003051			2
				5	1274200-018000	11072329	EMPAQUE	4
				6	1244200-008000	11072328	ANTIVIBRANTE	4
7		8	9	7	1250105-280000	11072971	PERNO HEX M10X1.25X60	2
				8	1251700-065000	11072330	BUJE D10 X D12 X 41	2
				9				

FIGURA 40: LEVA DE FRENO

				COMPONENTES	ÍTEM	REFERENCIA	COD. SAP	DESCRIPCIÓN	CANTIDAD
	1	2	3	1	1100100-831000	11072834	BOMBA DE FRENO DELANTERO	1	
				2	1100100-833000	11075486	LEVA DE FRENO	1	
				3	1186200-012000	11072431	COMANDO AUX DER (TAPA COMB - SILLÍN)	1	
	4	5	6	4	1250205-031091	11072243	TORNILLO M6 X 30	2	
				5	1190100-409051	11072491	ESPEJO RETROVISOR DERECHO	1	
				6	1251100-112000	11071991	PERN TUBO FRENO DE DISCO M10 X 1-22	1	
	7	8		7	1251513-013000	11072126	ARANDELA DE LATÓN D15 X D10,2 X 1,5	2	
				8	1100100-827000	11072960	PASTILLAS DE FRENO DELANTERO	1	
				9	1100100-092000	11072063	PASTILLAS FRENO TRASERAS	1	
	1	2	3	1	1100100-583000	11072083	SWITCH FRENO DELANTERO	1	
				2					
				3					
	4	5	6	4					
				5					
				6					
7	8	9	7						
			8						

FIGURA 41: SOPORTE MODULO ABS

COMPONENTES				ÍTEM	REFERENCIA	COD. SAP	DESCRIPCIÓN	CANTIDAD
	1	2	3	1	1274300-071094	11075377	SOPORTE MODULO ABS	1
				2	1251112-001093	11071977	PERNO HEX CON BRIDA M6 X 16	2
				3	1274100-007000	11072214	BUJE (6.4X9X6+20X2)	2
	4	5	6	4	1244100-004000	11072027	ANTIVIBRANTE AMORTIGUADOR	2
				5	1251100-102000	11071837	PERNO M6 X 16 (CUADRANTE ALLEN)	2
				6	1250501-010000	11071861	WASA METÁLICA (D6)	2
	7	8	9	7	1274300-065000	11075374	PLATINA	1
				8	1250105-138093	11071847	PERNO HEXAGONAL M6 X 20	1
				9				

FIGURA 42: TORNILLERIA

COMPONENTES				ÍTEM	REFERENCIA	COD. SAP	DESCRIPCIÓN	CANTIDAD
	1	2	3	1	1251100-112000	11071991	PERN TUBO FRENO DE DISCO M10 X 1-22	1
				2	1251100-101000	11071836	PERNO M6 X 12 (CUADRANTE ALLEN)	1
				3	1251112-001093	11071977	PERNO HEX CON BRIDA M6 X 16	2
	4	5	6	4	1244300-019000	11072914	GOMA TORNILLO PURGA CALIPER	1
				5	1251100-307000	11072979	PERNOS SISTEMA DE FRENOS M10X1X22	1
				6	1251100-308000	11073074	TORNILLO PURGA LIQUIDO FRENOS	1
	7	8	9	7	1251513-013000	11072126	ARANDE DE LATÓN D15 X D10,2 X 1,5	6
				8	1251100-303093	11072963	PERNO ALLEN M10X1.5X60	2
				9				

FIGURA 43: SOPORTE TUBOS SUSPENSIÓN DELANTERA

COMPONENTES			ÍTEM	REFERENCIA	COD. SAP	DESCRIPCIÓN	CANTIDAD	
	1	2	3	1	4094300-001051	11073065	SOPORTE TUBOS SUSPENSIÓN DEL	1
				2	1251500-100000	11075668	ARANDELA D22.5XD39X1	1
				3	1251300-088000	11073082	TUERCA M22X1	1
	4	5	6	4	1250205-023000	11072024	PERNO M8 X 35	2
				5	1184200-138000	11075563	SEGURO ELECTRONICO	1
				6	1251100-121093	11071975	PERNO M6 X 25	2
	7	8	9	7	1250501-007093	11071979	ARANDELA (D8)	2
				8				
				9				

FIGURA 44: CUNAS DIRECCIÓN

COMPONENTES			ÍTEM	REFERENCIA	COD. SAP	DESCRIPCIÓN	CANTIDAD	
	1	2	3	1	1134100-007000	11071863	ARANDELA DE BLOQUEO	1
				2	1251300-046093	11071865	TUERCA COLUMN DE DIREC M24 X 1	2
				3	1244100-015000	11071864	RETÉN DE GOMA PARA TUERC DE AJUSTE	1
	4	5	6	4	1130900-022000	11072246	RODAMIENTO SUPERIOR CUNAS	1
				5	1130900-024000	11071851	PISTA CUNAS DIRECCIÓN	1
				6	1244300-014000	11072917	GUARDAPOLVO SUPERIOR	1
	7	8	9	7				
				8				
				9				

FIGURA 45: HORQUILLA DIRECCIÓN

	COMPONENTES			ÍTEM	REFERENCIA	COD. SAP	DESCRIPCIÓN	CANTIDAD
	1	2	3	1	4094300-002051	11072923	HORQUILLA DIRECCIÓN	1
				2	1244300-015000	11072916	GUARDAPOLVO INFERIOR	1
				3	1134300-003000	11075347	CUNA INFERIOR	1
	4	5	6	4	1134300-002000	11073048	RODAMIENTO CUNAS DIRECCIÓN	1
				5	1250205-023000	11072024	PERNO M8 X 35	4
				6				
	7	8	9	7				
				8				
				9				

FIGURA 46: BARRAS DE SUSPENSION DELANTERA

	COMPONENTES			ÍTEM	REFERENCIA	COD. SAP	DESCRIPCIÓN	CANTIDAD
	1	2	3	1	1114300-005000	11075657	SUSPENSION DELANTERA IZQ	1
				2	1114300-006000	11075658	SUSPENSION DELANTERA DERECHA	1
				3	1250205-023000	11072024	PERNO M8 X 35	4
	4	5	6	4	1274300-008000	11072841	BUJE D20XD28X15.5	1
				5	1094100-063000	11072473	EJE HUECO RUEDA DELANTERA D20 X 243	1
				6	1094100-037000	11071957	BUJE DER RUEDA DELANTERA	1
	7	8	9	7	1174300-013000	11073016	REFLECTIVO AMARILLO	2
				8				
				9				

FIGURA 47: RUEDA DELANTERA

	COMPONENTES			ÍTEM	REFERENCIA	COD. SAP	DESCRIPCIÓN	CANTIDAD
		1	2	3	1	1094300-007021	11075378	RIN DELANTERO
				2	1230100-558000	11075385	LLANTA 120/70ZR17	1
				3	1100100-783000	11072881	DISCO DE FRENO DELANTE (320X5.0)	1
4		5	6	4	1251100-117093	11071921	PERNOS M8 X 25 (CUADRANT ALLEN)	5
				5	1184300-034000	11075384	SENSOR PRESIÓN LLANTA	1
				6	1244200-135000	11073031	RETENEDOR 28X42X7	2
7		8	9	7	1250601-119000	11073040	RODAMIENTO BOLAS 6004-2RS-C3	2
				8				
				9				

FIGURA 48: RUEDA FONICA RUEDA DELANTERA

	COMPONENTES			ÍTEM	REFERENCIA	COD. SAP	DESCRIPCIÓN	CANTIDAD
		1	2	3	1	1274300-007000	11073051	RUEDA FÓNICA ABS (60 TH)
				2	1250402-001091	11075834	REMACHE 3x10	5
				3	1181200-118000	11071986	SENSOR DE VELOCIDAD (A)	1
4		5	6	4	1251100-101000	11071836	PERNO M6 X 12 (CUADRANTE ALLEN)	1
				5	1224100-044000	11072009	GUIA SENSOR VELOCIDAD	4
				6				
				7				
				8				
				9				

FIGURA 49: BRAZO OSCILANTE

COMPONENTES			ÍTEM	REFERENCIA	COD. SAP	DESCRIPCIÓN	CANTIDAD	
	1	2	3	1	4074200-003051	11072835	BRAZO OSCILANTE	1
			 M20X1.5	2	1252200-040000	11075345	EJE D20X315	1
				3	1251300-067000	11071981	TUERCA EJE RUEDA TRASERA	1
				4	1274100-102000	11072837	BUJE	2
				5	1250602-035000	11071967	RODAMIENTO DE AGUJAS HK 2516	4
				6	1244200-079000	11072065	RETENEDOR D25 X D32 X 4	4
				7	1251100-204000	11072973	PERNO HEX M16X1.5X50	1
				8	1244200-086000	11075410	ANTIVIBRANTE IZQUIERDO	1
				9	1244200-085000	11075409	ANTIVIBRANTE DERECHO	1
				1	1244200-101000	11075898	TAPON BRAZO OSCILANTE	1
				2				
				3				
				4				
			5					
			6					
			7					
			8					

FIGURA 50: DESLIZADOR CADENA

	COMPONENTES			ÍTEM	REFERENCIA	COD. SAP	DESCRIPCIÓN	CANTIDAD
	1	2	3	1	1244200-055000	11075411	DESLIZADOR CADENA	1
				2	1274200-127000	11075842	SOPORTE MONTAJE BLOQUE ANTIFRICCIÓN	1
				3	1274100-057095	11072005	BUJE D6.2X8.4X3.5+14X1.5	5
	4	5	6	4	1251100-102000	11071837	PERNO M6 X 16 (CUADRANTE ALLEN)	5
				5				
				6				
	7	8	9	7				
				8				
				9				

FIGURA 51: GUARDABARRO TRASERO INFERIOR INTERNO

	COMPONENTES			ÍTEM	REFERENCIA	COD. SAP	DESCRIPCIÓN	CANTIDAD
	1	2	3	1	1224300-087000	11075383	GUARDABARRO TRASERO INF INT	1
				2	1251100-102000	11071837	PERNO M6 X 16 (CUADRANTE ALLEN)	2
				3	1250104-006097	11071992	PERNO HEXAGONAL M6 X 12	3
	4	5	6	4	1274100-057095	11072005	BUJE D6.2X8.4X3.5+14X1.5	5
				5	1244100-052000	11071842	BUJE DE GOMA (D8.5 X D14 X 1)	5
				6	1210343-056000	11084700	ADHESIVO DE CADENA	1
	7	8	9	7	1210342-424000	11075896	CALCOMAN GUARDABARRO INT TRAS	1
				8				
				9				

FIGURA 52: AMORTIGUADOR TRASERO

	COMPONENTES			ÍTEM	REFERENCIA	COD. SAP	DESCRIPCIÓN	CANTIDAD
		1	2	3	1	1114300-007000	11075364	AMORTIGUADOR TRASERO
				2	1251112-019000	11072958	PASADOR HEX M12X1.25X85	1
				3	1250305-009091	11072692	TUERCA M12 X 1.25	1
4		5	6	4	1251100-132003	11072015	PERNO HEXAGONAL M10 X 1,5 X 80	1
				5	1251300-057093	11072067	TUERCA SEGURIDAD M10X1.5	1
				6				
7		8	9	7				
				8				
				9				

FIGURA 53: COMPLEMENTO TIJERA

	COMPONENTES			ÍTEM	REFERENCIA	COD. SAP	DESCRIPCIÓN	CANTIDAD
		1	2	3	1	1020442-092000	11074348	ZT COMPLEME TIJERA SIN PINT 350
				2	1251100-101000	11071836	PERNO M6 X 12 (CUADRANTE ALLEN)	1
				3	1274100-057095	11072005	BUJE D6.2X8.4X3.5+14X1.5	1
4		5	6	4	1244100-052000	11071842	BUJE DE GOMA (D8.5 X D14 X 1)	1
				5				
				6				
7		8	9	7				
				8				
				9				

FIGURA 54: PROTECTOR SPROCKET

COMPONENTES			ÍTEM	REFERENCIA	COD. SAP	DESCRIPCIÓN	CANTIDAD	
	1	2	3	1	4024200-072051	11084185	PROTECTOR SPROCKET	1
				2	1274100-108000	11072842	BUJE D45XD35X5.5+D54XD35X2	1
				3	1244200-045000	11073033	RETENEDOR D45XD55X5	1
	4	5	6	4	1250601-095000	11073038	RODAMIENTO BOLAS	1
				5	1274100-105000	11072843	BUJE D46XD35X7.3	1
				6	1244200-088000	11072955	O-RING D52.4X2.6	1
	7	8	9	7	1094200-013000	11073014	PORTA CAUCHOS SPROCKET	1
				8	1244100-087000	11072856	CAUCHO PORTA SPROCKET	5
				9				

FIGURA 55: CADENA

COMPONENTES			ÍTEM	REFERENCIA	COD. SAP	DESCRIPCIÓN	CANTIDAD	
	1	2	3	1	1080100-112000	11073066	SPROCKET 520-43T	1
				2	1080200-055000	11075398	CADENA 520 114L	1
				3	1251300-057093	11072067	TUERCA SEGURIDAD M10X1.5	5
	4	5	6	4	1251100-190000	11072969	PERNO ESPECIAL M10X1.5X30	5
				5				
				6				
	7	8	9	7				
				8				
				9				

FIGURA 56: SOPORTE DENTADO BRAZO OSCILANTE

COMPONENTES			ÍTEM	REFERENCIA	COD. SAP	DESCRIPCIÓN	CANTIDAD	
	1	2	3	1	4024200-046000	11075897	SOPRO DENTADO BRAZO OSCILANTE	1
				2	1250700-009000	11072991	PIN DE SEGURIDAD D75X2.5	1
				3	1244200-044000	11073034	RETENEDOR D50XD62X5	2
	4	5	6	4	1250700-008000	11072990	PIN DE SEGURIDAD D62X2	2
				5	1250602-034000	11073037	RODAMIENTO AGUJAS NK50/25	1
				6	1250601-094000	11073047	RODAMIENTO BOLAS 6908RS	2
	7	8	9	7	1274100-104000	11072844	BUJE D50XD40X7.5	1
				8				
				9				

FIGURA 57: SOPORTE FRENO TRASERO

COMPONENTES			ÍTEM	REFERENCIA	COD. SAP	DESCRIPCIÓN	CANTIDAD	
	1	2	3	1	4024300-010000	11075373	SOPORTE FRENO TRASERO	1
				2	1251500-096000	11072823	ARANDELA D90XD76X1	1
				3	1244200-105000	11072956	O-RING D80X2.65	1
	4	5	6	4	1100100-732051	11075901	BLOQUE FRENO DE DISCO TRASERO	1
				5	1244200-066000	11072944	O-RING 22.2X2.4	1
				6	1251100-123093	11072322	PERNO M8 X 25	2
	7	8	9	7	1181200-118000	11071986	SENSOR DE VELOCIDAD (A)	1
				8	1251100-101000	11071836	PERNO M6 X 12 (CUADRANTE ALLEN)	1
				9				

FIGURA 58: EJE RUEDA TRASERA

		COMPONENTES			ÍTEM	REFERENCIA	COD. SAP	DESCRIPCIÓN	CANTIDAD
	1	2	3	1	4024200-048000	11072890	EJE-SOPORTE RUEDA TRASERA	1	
				2	1251100-191000	11072970	PERNO ESPECIAL M12X1.5X38	5	
				3	1250305-002091	11072319	TUERCA M8	5	
	4	5	6	4	1251100-117093	11071921	PERNOS M8 X 25 (CUADRANT ALLEN)	5	
				5	1100100-784000	11072882	DISCO DE FRENO TRASERO (265X4.5)	1	
				6	1274200-058000	11072221	RUEDA FÓNICA	1	
	7	8	9	7	1251300-070000	11073083	TUERCA M35X1.5	1	
				8	1094100-062000	11072993	PIN DE SEGURIDAD M35	1	
				9					

FIGURA 59: RUEDA TRASERA

		COMPONENTES			ÍTEM	REFERENCIA	COD. SAP	DESCRIPCIÓN	CANTIDAD
	1	2	3	1	1094300-008000	11075363	RIN TRASERO	1	
				2	1230100-564000	11075361	LLANTA 160/60ZR17	1	
				3	1251300-071000	11073078	TUERCA CIEGA M12X1.5	1	
	4	5	6	4	1210142-000100	11075893	TAPON	1	
				5	1260100-238000	11075878	PIN SEGURIDAD RIN TRASERO	1	
				6	1184300-034000	11075384	SENSOR PRESIÓN LLANTA	1	
	7	8	9	7					
				8					
				9					

FIGURA 60: PARTES CHASIS

COMPONENTES			ÍTEM	REFERENCIA	COD. SAP	DESCRIPCIÓN	CANTIDAD	
	1	2	3					
				2	1251100-262000	11072957	PASADOR HEX M12X1.25X127	1
				3	1250305-009091	11072692	TUERCA M12 X 1.25	1
	4	5	6	4	1244100-019000	11072858	CAUCHO TANQUE DE COMBUSTIBLE	1
				5	1244100-002000	11072295	BUJE DE GOMA CUBIERTA LATERAL	8
				6	1244100-061000	11071879	TAPÓN DE GOMA CHASIS	4
	7	8	9	7	1240300-007000	11072223	ANTIVIBRANTE BATERÍA	1
				8	1130900-026000	11071866	CUNA SUPERIOR	1
				9	1134300-001000	11072874	CUNA INFERIOR	1
	1	2	3	1	1224300-057000			2
				2	1224100-037000			2
				3	1274300-038000	11073011	PLATINA SOLENOIDE CANISTER	1
	4	5	6	4	1250303-010093	11072127	TUERCA M6	2
				5	1224300-086000	11075919	GUIA CABLES	1
				6				
				7				
				8				

FIGURA 61: PARTES ELECTRICAS

COMPONENTES			ÍTEM	REFERENCIA	COD. SAP	DESCRIPCIÓN	CANTIDAD	
	1	2	3	1	1184300-033000	11075324	RAMAL ELECTRICO	1
				2	1244200-139000	11072806	ANTIVIBRANTE 120MM	6
				3	1184200-016000	11071930	BOCINA ELECTRÓNICA	1
	4	5	6	4	1184100-017000	11071878	RELÉ DE INYECCIÓN DE COMBUSTI	5
				5	1180300-101000	11072500	FLASHER	1
				6	1184200-127000	11072911	FUSIBLE 10A	10
	7	8	9	7	1184200-128000	11072912	FUSIBLE 15A	7
				8	1184200-129000	11072913	FUSIBLE 25A	3
				9	1224300-093000	11075340	CORREA BELCRO	2
	1	2	3	1	1224100-030000	11079400	CORREA PLASTICA 4.8X130	3
				2	1244300-023000	11075490	ANTIVIBRANTE CAUCHO	3
				3				
	4	5	6	4				
				5				
				6				
	7	8	9	7				
				8				

FIGURA 62: PITO Y SEGURO SILLIN

	COMPONENTES			ÍTEM	REFERENCIA	COD. SAP	DESCRIPCIÓN	CANTIDAD
					1	1274100-058000	11072054	CERRADURA ELECTRÓNICA SILLÍN
2					1251100-101000	11071836	PERNO M6 X 12 (CUADRANTE ALLEN)	3
3					1224200-205000	11072318	PIN DE BLOQUEO SEGURO ELECTRÓ	1
				4	1184200-004000	11072069	PITO	1
				5	1050954-009000	11072034	SOLENOIDE DEL CANISTER	1
				6	1250303-010093	11072127	TUERCA M6	1
				7	1251112-001093	11071977	PERNO HEX CON BRIDA M6 X 16	1
				8				
				9				

FIGURA 63: REGULADOR

	COMPONENTES			ÍTEM	REFERENCIA	COD. SAP	DESCRIPCIÓN	CANTIDAD
					1	1184300-013000	11073017	REGULADOR RECTIFICADOR
2					1251100-061093	11071976	PERNO HEX CON BRIDA M6 X 22	4
3					1050958-006000	11075916	BOBINA DE ENCENDIDO	1
				4	1050958-007000	11072852	CAPUCHÓN BUJÍA	1
				5	1050958-004000	11072847	BUJÍA LDK8RTAIP	1
				6				
				7				
				8				
				9				

FIGURA 64: CONTROLADOR ENCENDIDO Y CONTROLES

	COMPONENTES			ÍTEM	REFERENCIA	COD. SAP	DESCRIPCIÓN	CANTIDAD
		1	2	3	1	1184300-024100	11072863	CONTROLAD ENCENDI Y CONTROL
				2	1251100-102000	11071837	PERNO M6 X 16 (CUADRANTE ALLEN)	2
				3	1274100-057095	11072005	BUJE D6.2X8.4X3.5+14X1.5	2
4		5	6	4	1244100-052000	11071842	BUJE DE GOMA (D8.5 X D14 X 1)	2
				5	1270300-273000	11072076	ABRAZADERA RAMAL	1
				6	1184200-092000	11084668	EMPAQUE	1
7		8	9	7	1184200-053000	11071916	ANTENA	1
				8	1184200-128000	11072912	FUSIBLE 15A	2
				9	1184200-182000	11077701	PILA PARA LLAVE CR1225	2

FIGURA 65: SENSOR SOPORTE LATERAL

	COMPONENTES			ÍTEM	REFERENCIA	COD. SAP	DESCRIPCIÓN	CANTIDAD
		1	2	3	1	1184100-012000	11072035	SENSOR SOPORTE LATERAL
				2	1250205-040095	11072023	PERNO HEXAGONAL M8 X 16	2
				3	1274100-017000	11072514	HEBILLA LÍNEA	2
4		5	6	4	1274100-095000	11072075	GUÍA CABLE	1
				5	1224100-037000	11078751	AMARRADERA PLASTICA 3.6X295	1
				6				
7		8	9	7				
				8				
				9				

FIGURA 66: SOPORTE MOTOR

		COMPONENTES			ÍTEM	REFERENCIA	COD. SAP	DESCRIPCIÓN	CANTIDAD
 				1	4024300-003021	11075362	SOPORTE MOTOR	1	
				2	1251112-019000	11072958	PASADOR HEX M12X1.25X85	2	
				3	1250305-009091	11072692	TUERCA M12 X 1.25	2	
				4	1274300-082000	11073007	PLATINA MOTOR	2	
				5	1251100-132003	11072015	PERNO HEXAGONAL M10 X 1,5 X 80	2	
				6	1251300-057093	11072067	TUERCA SEGURIDAD M10X1.5	2	
				7					
				8					
				9					

FIGURA 67: SOPORTE LATERAL

		COMPONENTES			ÍTEM	REFERENCIA	COD. SAP	DESCRIPCIÓN	CANTIDAD
				1	1271200-165000	11075564	SOPORTE LATERAL	1	
				2	1251100-088094	11071840	PERNO M10 X 1,5 X 43	1	
				3	1264100-001000	11072031	RESORTE DEL SOPORTE LATERAL	1	
				4	1251700-025091	11072032	BUJE DE SOPORTE LATERAL	1	
				5	1251300-057093	11072067	TUERCA SEGURIDAD M10X1.5	1	
				6					
				7					
				8					
				9					

FIGURA 68: CAJA FILTRO DE AIRE

	COMPONENTES			ÍTEM	REFERENCIA	COD. SAP	DESCRIPCIÓN	CANTIDAD
		1	2	3	1	1224300-002000	11072850	CAJA FILTRO DE AIRE
				2	1251300-063093	11072320	CHAPETA M6 X 11 X 15	6
				3	1251100-101000	11071836	PERNO M6 X 12 (CUADRANTE ALLEN)	6
4		5	6	4	1050961-004000	11073055	SENSOR IAT	1
				5	1224300-069000	11072851	CANISTER	1
				6	1244200-117000	11075900	MANGUERA D6xD10xL300	1
7		8	9	7	4134300-003000	11072910	FILTRO DE AIRE	1
				8				
				9				

FIGURA 69: CUERPO DE INYECCIÓN

	COMPONENTES			ÍTEM	REFERENCIA	COD. SAP	DESCRIPCIÓN	CANTIDAD
		1	2	3	1	1050958-001000	11072872	CUERPO DE INYECCIÓN
				2	1050958-003000	11075380	CONDUCTO DE ADMISIÓN	1
				3	1051354-004000	11072351	ABRAZADERA D 56 X 10	1
4		5	6	4	1051454-016000	11072949	O-RING 45X2.5	1
				5	1251100-061093	11071976	PERNO HEX CON BRIDA M6 X 22	2
				6	1050954-025000	11072541	MOTOR PASO A PASO	1
7		8	9	7				
				8				
				9				

FIGURA 70: SOPORTE INYECTOR

	COMPONENTES			ÍTEM	REFERENCIA	COD. SAP	DESCRIPCIÓN	CANTIDAD
		1	2	3	1	1050961-003000	11073056	SENSOR MAP
				2	1050958-008000	11072933	MANGUERA	1
				3	1251100-314000	11073072	TORNILLO M5X20	1
4		5	6	4	1050958-009000	11075661	PLATINA SENSOR PRESION ENTRADA AIRE	1
				5	1250105-138093	11071847	PERNO HEXAGONAL M6 X 20	1
				6	1050954-023000	11072516	INYECTOR	1
7		8	9	7	1050970-002000	11072650	SOPORTE INYECTOR	1
				8				
				9				

FIGURA 71: MOTOR

	COMPONENTES			ÍTEM	REFERENCIA	COD. SAP	DESCRIPCIÓN	CANTIDAD
		1	2	3	1	5580101-001051		
				2	1051354-008000	11073006	PLATINA CABLE CLUTCH	1
				3				
4		5	6	4				
				5				
				6				
7		8	9	7				
				8				
				9				

FIGURA 72: TAPA TRASERA IZQUIERDA MOTOR

	COMPONENTES			ÍTEM	REFERENCIA	COD. SAP	DESCRIPCIÓN	CANTIDAD
		1	2	3	1	4050854-002051	11084701	CUBIERTA TRASERA IZQ MOTOR
				2	1251112-003093	11071982	PERNO HEXAGONAL M6 X 45	2
				3				
4		5	6	4				
				5				
				6				
7		8	9	7				
				8				
				9				

FIGURA 73: SILENCIADOR

	COMPONENTES			ÍTEM	REFERENCIA	COD. SAP	DESCRIPCIÓN	CANTIDAD
		1	2	3	1	4084300-012000	11075391	SILENCIADOR
				2	1070100-499000	11072900	EMPAQUE MOFLE	1
				3	1251300-058093	11072002	TUERCA HEXAGONAL M8	2
4		5	6	4	1020243-097000	11072845	BUJE D8.3XD11.5X20.5XD8.4XD33X1.5	2
				5	1244300-022000	11072809	ANTIVIBRANTE SUSPENSIÓN	2
				6	1020243-098000	11072901	EMPAQUE MOFLE D8.3XD33X1.5	1
				7	1250205-125000	11072967	PERNO ALLEN M8X35	2
				8	1124300-004000	11072903	EMPAQUE MOFLE 37.8X28X11	1
				9	1050970-011000	11073054	SENSOR DE OXÍGENO	1

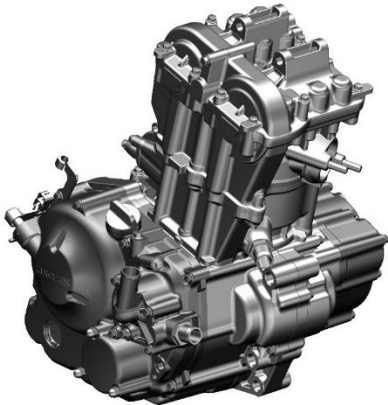
FIGURA 74: PARTE TRASERA SILENCIADOR

	COMPONENTES			ÍTEM	REFERENCIA	COD. SAP	DESCRIPCIÓN	CANTIDAD
		1	2	3	1	4084300-011051	11073057	SILENCIADOR
				2	1274100-074000	11072804	ABRAZADERA METÁLICA MOFLE	1
				3	1250205-023000	11072024	PERNO M8 X 35	1
4		5	6	4	4084300-010051	11072871	CUBIERTA SILENCIADOR	1
				5	1250501-010000	11071861	WASA METÁLICA (D6)	3
				6	1251100-101000	11071836	PERNO M6 X 12 (CUADRANTE ALLEN)	3
7		8	9	7	1020243-097000	11072845	BUJE D8.3XD11.5X20.5XD8.4XD33X1.5	1
				8	1244300-022000	11072809	ANTIVIBRANTE SUSPENSIÓN	1
				9	1250205-125000	11072967	PERNO ALLEN M8X35	1

FIGURA 75: SOPORTE REPOSAPIES IZQUIERDO

	COMPONENTES			ÍTEM	REFERENCIA	COD. SAP	DESCRIPCIÓN	CANTIDAD
		1	2	3	1	4064300-022051	11073064	SOPORTE REPOSAPIES IZQUIERDO
				2	1250205-023000	11072024	PERNO M8 X 35	2
					1250205-034093	11072966	PERNO ALLEN M8X30	1
				3	1244100-002000	11072295	BUJE DE GOMA CUBIERTA LATERAL	2
4		5	6	4	4064300-011051	11073021	REPOSAPIE TRASERO IZQ COMPLETO	1
				5	1260100-301000	11075346	RESORTE REPOSAPIE	1
				6	1274300-031000	11075485	BALIN REPOSAPIE	1
				7	1274300-032000	11071902	PLATINA DE POSICIÓN	1
				8	1274300-033000	11071901	PIN REPOSAPIE	1
			9	1264100-006000	11072237	PIN DE SEGURIDAD DEL PEDAL	1	

FIGURA 76: REPOSAPIE DELANTERO IZQUIERDO

	COMPONENTES			ÍTEM	REFERENCIA	COD. SAP	DESCRIPCIÓN	CANTIDAD
		1	2	3	1	4064300-009051	11073019	REPOSAPIE DELANT IZQ COMPLETO
				2	1264100-003000	11072013	RESORTE PEDAL DELANTERO IZQ	1
				3	1274300-033000	11071901	PIN REPOSAPIE	1
4		5	6	4	1264100-006000	11072237	PIN DE SEGURIDAD DEL PEDAL	1
				5				
				6				
7		8	9	7				
				8				
				9				

FIGURA 77: SOPORTE DE BLOQUEO DE FRENO DE DISCO

	COMPONENTES			ÍTEM	REFERENCIA	COD. SAP	DESCRIPCIÓN	CANTIDAD
		1	2	3	1	1274200-037000	11075840	SOP DE BLOQ DEL FRENO DE DIS
				2	1251100-101000	11071836	PERNO M6 X 12 (CUADRANTE ALLEN)	1
				3	1251100-102000	11071837	PERNO M6 X 16 (CUADRANTE ALLEN)	1
4		5	6	4				
				5				
				6				
7		8	9	7				
				8				
				9				

FIGURA 78: MUÑOON PEDAL DE CAMBIOS

	COMPONENTES			ÍTEM	REFERENCIA	COD. SAP	DESCRIPCIÓN	CANTIDAD
		1	2	3	1	1271200-163000	11072940	MUÑOON PEDAL DE CAMBIOS
				2	1251100-061093	11071976	PERNO HEX CON BRIDA M6 X 22	3
				3	1250303-010093	11072127	TUERCA M6	2
4		5	6	4	1274100-042000	11071988	COJINETE DE RÓTULA SAJK6C	1
				5	1250301-020093	11072003	TUERCA M6	1
				6	1274300-026000	11075349	EJE ROSCADO AJUSTE PEDAL CAMBIOS	1
7		8	9	7	1274100-043000	11071987	COJINETE DE RÓTULA SALJK6C	1
				8	1250301-018093	11072073	TUERCA M6	1
				9				

FIGURA 79: PEDAL DE CAMBIOS

	COMPONENTES			ÍTEM	REFERENCIA	COD. SAP	DESCRIPCIÓN	CANTIDAD
		1	2	3	1	1274300-020000	11075482	PEDAL DE CAMBIOS
				2	1274300-027000	11075645	ARANDELA PEDAL CAMBIOS	1
				3	1250205-124000	11073071	TORNILLO ALLEN M8X30	1
4		5	6	4	1274300-028000	11075353	TORNILLO	1
				5	1244100-031000	11072855	CAUCHO PEDAL DE CAMBIOS	1
				6	1250301-033000	11073086	TUERCA M8	3
7		8	9	7	1251300-094000	11073085	TUERCA M8	1
				8	1250401-011093	11072994	PIN METÁLICO	1
				9				

FIGURA 80: SOPORTE REPOSAPIES DERECHO

COMPONENTES			ÍTEM	REFERENCIA	COD. SAP	DESCRIPCIÓN	CANTIDAD	
	1	2	3	1	4064300-021051	11073063	SOPORTE REPOSAPIES DERECHO	1
				2	1250205-023000	11072024	PERNO M8 X 35	2
				2	1250205-034093	11072966	PERNO ALLEN M8X30	1
	4	5	6	3	1244100-002000	11072295	BUJE DE GOMA CUBIERTA LATERAL	3
				4	4064300-012051	11073020	REPOSAPIE TRASER DER COMPLETO	1
				5	1260100-301000	11075346	RESORTE REPOSAPIE	1
	7	8	9	6	1274300-031000	11075485	BALIN REPOSAPIE	1
				7	1274300-032000	11071902	PLATINA DE POSICIÓN	1
				8	1274300-033000	11071901	PIN REPOSAPIE	1
				9	1264100-006000	11072237	PIN DE SEGURIDAD DEL PEDAL	1
10			10	1244300-039000	11072807	ANTIVIBRANTE MOFLE	2	

FIGURA 81: TORNILLO PEDAL FRENO

COMPONENTES			ÍTEM	REFERENCIA	COD. SAP	DESCRIPCIÓN	CANTIDAD	
	1	2	3	1	1250900-302000	11073091	TORNILLO PEDAL FRENO	1
				2	1250301-023093	11073084	TUERCA M5	1
				3				
	4	5	6	4				
				5				
				6				
	7	8	9	7				
				8				
				9				

FIGURA 82: PEDAL DE FRENO

			COMPONENTES			ÍTEM	REFERENCIA	COD. SAP	DESCRIPCIÓN	CANTIDAD
	1	2	3	1	1274300-018000	11075481	SOPORTE PEDAL DE FRENO	1		
				2	1260100-303000	11073024	RESORT RETORNO PEDAL DE FRENO	1		
				3	1274300-027000	11075645	ARANDELA PEDAL CAMBIOS	1		
	4	5	6	4	1250205-124000	11073071	TORNILLO ALLEN M8X30	1		
				5	1274300-019000	11072962	PEDAL DE FRENO	1		
				6	1251112-001093	11071977	PERNO HEX CON BRIDA M6 X 16	3		
	7	8	9	7						
				8						
				9						

FIGURA 83: CUBIERTA BOMBA DE FRENO TRASERO

	COMPONENTES			ÍTEM	REFERENCIA	COD. SAP	DESCRIPCIÓN	CANTIDAD
		1	2	3	1	1224300-023000	11072865	CUB BOMBA DE FRENO TRASERO
				2	1251100-101000	11071836	PERNO M6 X 12 (CUADRANTE ALLEN)	3
				3	1244100-052000	11071842	BUJE DE GOMA (D8.5 X D14 X 1)	3
4		5	6	4	1274100-057095	11072005	BUJE D6.2X8.4X3.5+14X1.5	3
				5				
				6				
				7				
				8				
				9				

FIGURA 84: PLATINA MOFLE

	COMPONENTES			ÍTEM	REFERENCIA	COD. SAP	DESCRIPCIÓN	CANTIDAD
		1	2	3	1	1020443-011000	11075351	PLATINA MOFLE
				2				
				3				
4		5	6	4				
				5				
				6				
				7				
				8				
				9				

FIGURA 85: BASE REPOSAPIE

				COMPONENTES	ÍTEM	REFERENCIA	COD. SAP	DESCRIPCIÓN	CANTIDAD
	1	2	3	1	1244300-013000	11072857	CAUCHO REPOSAPIE	4	
				2	1274300-094093	11075921	PLATINA REPOSAPIE	4	
				3	1251100-167000	11072045	PERNO DE CABEZA ESFÉRICA M6 X 8	2	
	4	5	6	4	1250205-038000	11071862	TORNILLO M5 X 12 (CUADRANTE ALLEN)	4	
				5	4064300-005051	11072830	BASE REPOSAPIE DELANTERO IZQ	1	
				6	4064300-006051	11072829	BASE REPOSAPIE DELANTERO DER	1	
				7	4064300-007051	11072832	BASE REPOSAPIE TRASERO IZQ	1	
				8	4064300-008051	11072831	BASE REPOSAPIE TRASERO DER	1	
			9	9	1250501-010000	11071861	WASA METÁLICA (D6)	4	

FIGURA 86: RADIADOR

				COMPONENTES	ÍTEM	REFERENCIA	COD. SAP	DESCRIPCIÓN	CANTIDAD
	1	2	3	1	1274300-023000	11075354	RADIADOR IZQUIERDO	1	
				2	1274300-024000	11075355	RADIADOR DERECHO	1	
				3	1244200-011000	11075839	MANGUERA CONEXIÓN TANQUE AGUA IZQ Y DER	1	
	4	5	6	4	1274200-090000	11072348	ABRAZADERA (D26)	2	
				5	1244100-002000	11072295	BUJE DE GOMA CUBIERTA LATERAL	4	
				6	1251100-061093	11071976	PERNO HEX CON BRIDA M6 X 22	5	
				7	1276200-043000	11072350	ABRAZADERA ALAMBRE	2	
				8					
				9					

FIGURA 87: TAPA RADIADOR

	COMPONENTES			ÍTEM	REFERENCIA	COD. SAP	DESCRIPCIÓN	CANTIDAD
		1	2	3	1	1224300-020000	11075356	TAPA RADIADOR
				2	1274300-025000	11075357	PLATINA RESERVORIO	1
				3	1244300-009000	11075358	MANGUERA INGRESO REFRIGERANTE	1
4		5	6	4	1274200-089000	11072043	ABRAZADERA METÁLICA (D 22)	2
				5	1250104-006097	11071992	PERNO HEXAGONAL M6 X 12	1
				6	1251100-101000	11071836	PERNO M6 X 12 (CUADRANTE ALLEN)	1
7		8	9	7				
				8				
				9				

FIGURA 88: TANQUE RESERVORIO

	COMPONENTES			ÍTEM	REFERENCIA	COD. SAP	DESCRIPCIÓN	CANTIDAD
		1	2	3	1	1224300-019000	11075359	TANQUE RESERVORIO
				2	1244300-010000	11075360	MANGUERA AUX	1
				3	1274200-088000	11072042	ABRAZADERA (D 10.5)	2
4		5	6	4	1274200-079000	11072349	ABRAZADERA (D9)	1
				5	1244200-025000	11072935	MANGUERA DRENAJE RESERVORIO	1
				6	1251100-061093	11071976	PERNO HEX CON BRIDA M6 X 22	1
7		8	9	7	1224300-050000	11075382	GUIA MANGUERA TARRO AUX	
				8				
				9				

FIGURA 89: TERMOSTATO Y MANGUERAS

	COMPONENTES			ÍTEM	REFERENCIA	COD. SAP	DESCRIPCIÓN	CANTIDAD
	1	2	3	1	1244200-001000	11072938	MANGU SALIDA AGUA DEL MOTOR	1
				2	1274200-019000	11075403	TERMOSTATO	1
	4	5	6	3	1244200-010000	11072937	MANGUERA INGRESO DE AGUA	1
				4	1244200-021000	11075413	MANGUERA PEQUEÑA	1
	7	8	9	5	1244200-098000	11075412	MANGUE INGRESO REFRIGERANT MOTOR	1
				6	1244200-012000	11072936	MANGUERA INGRESO AGUA AL MOTOR	1
	10			7	1274200-089000	11072043	ABRAZADERA METÁLICA (D 22)	1
				8	1274200-090000	11072348	ABRAZADERA (D26)	4
				9	1274200-091000	11072803	ABRAZADERA METÁLICA D27	2
				10	1274200-041000	11072347	ABRAZADERA (D26)	3

FIGURA 90: RADIADOR DE ACEITE

	COMPONENTES			ÍTEM	REFERENCIA	COD. SAP	DESCRIPCIÓN	CANTIDAD
		1	2	3	1	<u>1274300-125000</u>	<u>11079720</u>	<u>RADIADOR DE ACEITE</u>
				2	1274300-036000	11075387	PLATINA SUPERIOR RADIADOR	1
				3	1274300-037000	11075350	PLATINA INF RADIADOR	1
4		5	6	4	1251112-001093	11071977	PERNO HEX CON BRIDA M6 X 16	3
				5	1251112-002093	11071978	PERNO HEX M6 X 30	1
				6	1251100-061093	11071976	PERNO HEX CON BRIDA M6 X 22	1
7		8	9	7	Si se va a cambiar el radiador de aceite, se deben solicitar las referencias subrayadas en amarillo con su respectiva cantidad.			
				8				
				9				

FIGURA 91: TUBO ENTRADA – SALIDA DE ACEITE DE ACEITE

	COMPONENTES			ÍTEM	REFERENCIA	COD. SAP	DESCRIPCIÓN	CANTIDAD
					1	<u>1274300-126000</u>	<u>11079721</u>	<u>TUBO ENTRADA ACEITE</u>
				2	<u>1274300-127000</u>	<u>11079722</u>	<u>TUBO SALIDA ACEITE</u>	<u>1</u>
				3	<u>1251100-061093</u>	<u>11071976</u>	<u>PERNO HEX CON BRIDA M6 X 22</u>	<u>2</u>
				4	<u>1251112-001093</u>	<u>11071977</u>	<u>PERNO HEX CON BRIDA M6 X 16</u>	<u>2</u>
				5	<u>1051454-025000</u>	<u>11072954</u>	<u>O-RING 9.8X2.4</u>	<u>4</u>
				6				
				7				
				8				
				9				

FIGURA 92: CULATA

				COMPONENTES	ÍTEM	REFERENCIA	COD. SAP	DESCRIPCIÓN	CANTIDAD
	1	2	3	1	4050658-004000	11075907	CULATA SUBCONJUNTO	1	
				2	1050153-005000	11075416	TAPON CULATA	2	
				3	1251112-024000	11075673	EJE HEX M8X1X117	2	
	4	5	6	4	1251401-004000	11075343	BUJE D12X20	1	
					1251401-001000	11071829	GUÍA CARCASA D8 X 14	2	
				5	1051454-027000	11072953	O-RING 7.5X1.5	1	
				6	1251300-052094	11073077	TUERCA CIEGA	4	
	7	8	9	7	1251500-041000	11072324	ARANDELA 10,3 X 20 X 2	4	
				8	1051658-001000	11072899	EMPAQUE CULATA	1	
			9	1051658-002000	11072902	EMPAQUE TAPA CULATA	1		

FIGURA 93: CULATA

	COMPONENTES			ÍTEM	REFERENCIA	COD. SAP	DESCRIPCIÓN	CANTIDAD
		1	2	3	1	4050658-008000	11075924	SUBCONJUN ÁRBOL DE LEVAS CULA
2		4	6	2	1051158-001000	11072848	BUJÍA LDK9RTIP	1
				2	1050958-004000	11072847	BUJÍA LDK8RTAIP	1
3		5	9	3	1051454-007000	11072943	O-RING 19X2.65	1
				4	1051954-001000	11075405	CONDUCTO	1
5		8	9	5	1251112-001093	11071977	PERNO HEX CON BRIDA M6 X 16	2
				6	1051454-009000	11072050	O-RING 9 X 2	1
7		8	9	7	1050954-003000	11071870	SENSOR DE TEMPERATURA	1
8			8					

FIGURA 94: CULATA

	COMPONENTES			ÍTEM	REFERENCIA	COD. SAP	DESCRIPCIÓN	CANTIDAD
		1	2	3	1	4050658-009000	11075925	SUBCONJ DE VÁLVULAS DE CULATA
2		4	6	2	1050154-020000	11074406	SHIM	4
				3	1050158-009000	11075920	TAQUÉ VALVULA	4
4		5	9	4	4051758-008000	11072887	EJE DE LEVAS ADMISIÓN	1
				5	4051758-009000	11072888	EJE DE LEVAS ESCAPE	1
6				6				
7				7				
8				8				
9				9				

FIGURA 95: CULATA

	COMPONENTES			ÍTEM	REFERENCIA	COD. SAP	DESCRIPCIÓN	CANTIDAD
		 1	 2	 3	1	4050658-005000	11072873	CULATA
				2	1050153-015000	11075675	ARANDELA 16.5x23.5x1	4
				3	1051553-001000	11072016	RETÉN VÁLVULA	4
 4		 5	 6	4	1050158-006000	11073087	VÁLVULA DE ADMISIÓN	4
				5	1050158-007000	11073088	VÁLVULA DE ESCAPE	4
				6	1050158-001000	11073025	RESORTE VÁLVULA	4
 7		 8	 9	7	1050154-039000	11073026	RESORTE VÁLVULA	4
				8	1050154-016000	11075422	ARANDELA SUP VALVULA	4
				9	1050158-008000	11072876	CUÑA VÁLVULA	8
 10		 11	 12	10	1251111-011000	11071873	ESPARRAGO M8 X 38	2
				11	1251112-003093	11071982	PERNO HEXAGONAL M6 X 45	12
				12	1251401-001000	11071829	GUÍA CARCASA D8 X 14	10

FIGURA 96: TAPA CULATA

	COMPONENTES			ÍTEM	REFERENCIA	COD. SAP	DESCRIPCIÓN	CANTIDAD
		 1	 2	 3 <small>Φ6.3XΦ12X1.6</small>	1	4050758-001000	11073067	TAPA CULATA
				2	1050154-034000	11073012	PLATINA TAPA CULATA	1
				3	1251513-001019	11071896	ARANDELA DE COBRE 6.3X12X1.6	1
 4		 5	 6	4	1251100-067093	11071833	PERNO M6X10	1
				5	1250205-023000	11072024	PERNO M8 X 35	1
				6	1251112-003093	11071982	PERNO HEXAGONAL M6 X 45	2
 7		 8	 9	7	1251112-002093	11071978	PERNO HEX M6 X 30	8
				8	1051658-002000	11072902	EMPAQUE TAPA CULATA	1
				9				

FIGURA 97: KIT CILINDRO

COMPONENTES			ÍTEM	REFERENCIA	COD. SAP	DESCRIPCIÓN	CANTIDAD	
	1	2	3	1	4050558-003000	11072925	KIT CILINDRO	1
				2	1051658-001000	11072899	EMPAQUE CULATA	1
				3	1051658-007000	11072896	EMPAQUE CILINDRO	1
	4	5	6	4	1251112-002093	11071978	PERNO HEX M6 X 30	1
				5	1051301-052000	11072511	GUÍA CARCASA 12 20	2
				6	1251401-001000	11071829	GUÍA CARCASA D8 X 14	1
	7	8	9	7	1051161-003000	11072985	PIN CILINDRICO D9X14	1
				8	1244200-012000	11072936	MANGUE INGRESO AGUA AL MOTOR	1
				9	1274200-041000	11072347	ABRAZADERA (D26)	2

FIGURA 98: CILINDRO COMPLETO

COMPONENTES			ÍTEM	REFERENCIA	COD. SAP	DESCRIPCIÓN	CANTIDAD	
	1	2	3	1	4050558-004000	11075402	CILINDRO COMPLETO	1
				2	1050458-008000	11072927	KIT PISTÓN	1
				3				
	4	5	6	4				
				5				
				6				
	7	8	9	7				
				8				
				9				

FIGURA 99: CILINDRO SOLO

	COMPONENTES			ÍTEM	REFERENCIA	COD. SAP	DESCRIPCIÓN	CANTIDAD
		1	2	3	1	4050558-001000	11072860	CILINDRO SOLO
				2	1051954-007000	11075684	CONDUCTO	1
				3	1051454-008000	11072942	O-RING 19X1.5	1
4		5	6	4				
				5				
				6				
7		8	9	7				
				8				
				9				

FIGURA 100: PISTON

	COMPONENTES			ÍTEM	REFERENCIA	COD. SAP	DESCRIPCIÓN	CANTIDAD
		1	2	3	1	1050458-001000	11075533	PISTON
				2	1050458-003000	11075510	ANILLO	1
				3	1050458-004000	11075905	ANILLO PISTÓN #2	1
4		5	6	4	1050458-005000	11072924	KIT ANILLOS PISTÓN	1
				5	1050458-002000	11072959	PASADOR PISTÓN	1
				6	1050454-007000	11072995	PIN PASADOR PISTÓN	1
7		8	9	7				
				8				
				9				

FIGURA 101: CLUTCH

	COMPONENTES			ÍTEM	REFERENCIA	COD. SAP	DESCRIPCIÓN	CANTIDAD
		1	2	3	1	4051658-011000	11075365	ORONA CLUTCH
				2	1050754-006000	11075415	EMPUJADOR CLUTCH	1
				3	1251311-001094	11072060	TUERCA M16 X 1	1
4		5	6	4	1251514-002000	11072061	ARANDE SEGURID 16,2 X 28 X 2,4 X 2	1
				5	1251512-011000	11072813	ARANDELA 16.2X30X1	1
				6	1250602-014000	11073036	RODAMIENTO AGUJAS	1
7		8	9	7	1050753-010000	11072839	BUJE CLUTCH	1
				8	1050753-022000	11072840	BUJE CORONA CLUTCH	1
				9				

FIGURA 102: CLUTCH

	COMPONENTES			ÍTEM	REFERENCIA	COD. SAP	DESCRIPCIÓN	CANTIDAD
		1	2	3	1	4051058-003000	11075912	CLUTCH COMPLETO
				2	1050758-001000	11075386	CORONA CLUTCH	1
				3	1251512-022000	11072814	ARANDELA 22.2X37X2	1
4		5	6	4				
				5				
				6				
7		8	9	7				
				8				
				9				

FIGURA 103: CLUTCH

	COMPONENTES			ÍTEM	REFERENCIA	COD. SAP	DESCRIPCIÓN	CANTIDAD
		1	2	3	1	1251512-031000	11072818	ARANDELA 96.3X107X7
				2	1251514-006000	11072895	EMPAQUE CAUCHO 96.5X107X2.2X1	1
				3	1050753-012000	11075408	SEPARADOR CLUTCH	5
4		5	6	4	1050754-022000	11072883	DISCOS SEPARADORES CLUTCH	1
				5	1051454-017000	11075344	ANTIVIBRANTE CLUTCH	3
				6	1050758-002000	11073022	RESORTE DE CLUTCH	3
7		8	9	7	1050754-007000	11073004	PLACA PRESIÓN RESORTES CLUTCH	1
				8	1251100-070093	11072974	PERNO HEX M6X30	3
				9	1050754-023000	11072926	KIT DISCOS CLUTCH	1
1		2	3	1	1050754-002000	11075414	PORTA RESORTES CLUTCH	1
				2	1050754-024000	11075419	PRENSA CLUTCH	1
				3				
4		5	6	4				
				5				
				6				
7		8	9	7				
				8				

FIGURA 104: TRANSMISIÓN

	COMPONENTES			ÍTEM	REFERENCIA	COD. SAP	DESCRIPCIÓN	CANTIDAD
		1	2	3	1	4051758-010000	11075367	EJE CLUTCH COMPLETO
				2	4051758-012000	11075366	EJE SALIDA COMPLETO	1
				3				
4		5	6	4				
				5				
				6				
7		8	9	7				
				8				
				9				

FIGURA 105: PIÑÓN DE SALIDA

	COMPONENTES			ÍTEM	REFERENCIA	COD. SAP	DESCRIPCIÓN	CANTIDAD
		1	2	3	1	1050354-023000	11073001	PIÑÓN DE SALIDA
				2	1251300-066093	11073080	TUERCA M18X1.0	1
				3	1051354-002000	11072827	ARANDEL SEGURIDAD PIÑÓN SALIDA	1
4		5	6	4	1050254-001000	11072846	BUJE EJE PIÑÓN DE SALIDA	1
				5	1051454-019000	11072945	O-RING 22.5X2.5	2
				6				
7		8	9	7				
				8				
				9				

FIGURA 106: EJE DE CAMBIOS

COMPONENTES			ÍTEM	REFERENCIA	COD. SAP	DESCRIPCIÓN	CANTIDAD	
				1	1050658-002000	11073052	SELECTOR DE CAMBIOS	1
				2	1050658-003000	11072838	BUJE	1
				3	1050658-006000	11072885	EJE DE CAMBIOS	1
				4	1050658-008000	11072982	PIN CILINDRICO D2X10	1
				5	1050654-002000	11072920	HORQUILLA CAMBIOS	1
				6	1050654-004000	11072922	HORQUILLA CAMBIOS	1
				7	1050654-003000	11072921	HORQUILLA CAMBIOS	1
				8	1050653-007000	11072889	EJE HORQUILLA CAMBIOS	1
				9	1250404-003000	11072983	PIN CILINDRICO D3X10	1
				1	1251512-001000	11072816	ARANDELA 6.2X15X1	1
				2	1050654-008000	11075407	RESORTE	1
				3	1050653-002000	11072929	LEVA DE CAMBIOS	1
				4	1251112-002093	11071978	PERNO HEX M6 X 30	1
				5	1050654-007000	11074441	PIN CONTACTO SENSOR CAMBIOS	1
				6	1050658-001000	11072905	ESTRELLA SELECTORA	1
				7	1251100-068093	11071832	PERNO M6X14-9X2.6	1
				8				

FIGURA 107: CARCASA IZQUIERDA

COMPONENTES			ÍTEM	REFERENCIA	COD. SAP	DESCRIPCIÓN	CANTIDAD		
	1	2	3	1	4050158-002000	11075910	CARCASA IZQ SUBCONJUNTO	1	
				2	1051658-004000	11072894	EMPAQUE CARCASA	1	
				3	1051358-011000	11073010	PLATINA SENSOR DE CAMBIOS	1	
				4	1251100-067093	11071833	PERNO M6X10	2	
				5	1050654-005000	11073053	SENSOR DE CAMBIOS	1	
				6	1051454-019000	11072945	O-RING 22.5X2.5	1	
				7	1250201-034093	11071999	TORNILLO M5 X 20 (PHILLIPS)	2	
				8	1050858-005000	11072981	PIN 1.2X6X12	2	
				9					
		1	2	3	1	1051461-008000	11072948	O-RING 4.5X1	4
				2	1251112-002093	11071978	PERNO HEX M6 X 30	3	
				3	1251112-005093	11072244	PERNO CON BRIDA M6 X 75	8	
				4	1251112-006093	11072975	PERNO HEX M6X90	2	
				5	1251401-001000	11071829	GUÍA CARCASA D8 X 14	2	
				6					
				7					
				8					

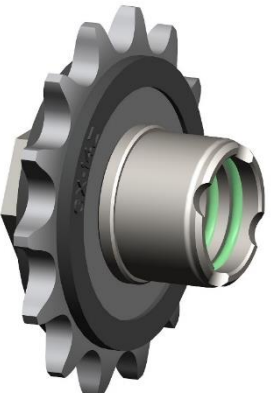
FIGURA 108: CARCASA IZQUIERDA

COMPONENTES			ÍTEM	REFERENCIA	COD. SAP	DESCRIPCIÓN	CANTIDAD	
	1	2	3	1	4050158-003000	11075911	CARCASA IZQUIERDA COMPLETA	1
				2	1051354-003000	11073008	PLATINA RODAMIENTO	2
				3	1251100-066093	11071858	PERNO M12 X 1,5 X 15	1
	4	5	6	4	1251400-002000	11075342	TORNILLO M10X1.25	1
				5	1051354-001000	11075837	TAPA DEL SELLO DE ACEITE DEL SUB-EJE	1
				6	1251100-067093	11071833	PERNO M6X10	4
	7	8	9	7	1244100-033000	11071857	RETENEDO COMBINADO 12 X D20 X 2	1
				8	1251513-004019	11072826	ARANDELA DE COBRE	1
				9				

FIGURA 109: CARCASA IZQUIERDA

COMPONENTES			ÍTEM	REFERENCIA	COD. SAP	DESCRIPCIÓN	CANTIDAD	
	1	2	3	1	4050158-003000	11075911	CARCASA IZQUIERDA COMPLETA	1
				2	1051161-008000	11075368	CONDUCTO LIQUID REFRIGERNATE	1
				3	1250601-036000	11072287	RODAMIENTO DE BOLAS 6202RS	1
	4	5	6	4	1050558-003000	11073044	RODAMIENTO BOLAS 63/22/P53	1
				5	1250601-056000	11073045	RODAMIENTO BOLAS 63/23RS/P5	1
				6	1050658-004000	11073046	RODAMIENTO BOLAS 6804P 63	1
	7	8	9	7	1250602-022000	11071954	RODAMIENTO DE AGUJAS HK 1010	1
				8	1051554-002000	11073032	RETENEDOR 30X42X7	1
				9	1051561-002000	11073030	RETENEDOR 14X25X7	1
	1	2	3	1	1051353-014000	11072086	BUJE	1
				2	1050853-020000	11074449	TAPÓN ACEITE	2
				3	1251111-005094	11075406	ESPARRA M10X1.25-M10X1.25X168	2
	4	5	6	4				
				5				
				6				
	7	8	9	7				
				8				

FIGURA 110: CIGÜEÑAL

				ÍTEM	REFERENCIA	COD. SAP	DESCRIPCIÓN	CANTIDAD
	COMPONENTES							
	1	2	3	1	4051758-007000	11072859	CIGÜEÑAL	1
				2	4051758-006000	11072828	BALANCEADOR	1
				3	1050454-017000	11075375	RODAMIENTO CIGÜEÑAL	1
	4	5	6	4	1050154-041000	11075844	SOPO DENTADO BRAZO OSCILANTE	1
				5	1251802-004000	11072048	CUÑA 5 X 5,5 X 26 X 9	1
				6	1050358-005000	11073002	PIÑÓN PRIMARIO	1
	7	8	9	7	1050358-007000	11072999	PIÑÓN BOMBA DE AGUA	1
				8	1251801-003000	11072875	CUÑA 5X5.5X19.2	1
				9	1251514-003000	11072824	ARANDELA DE BLOQUEO 18.2X30X2.5X2	1
	1	2	3	1	1251311-002094	11073081	TUERCA M18X1.0	1
				2				
				3				
	4	5	6	4				
				5				
				6				
	7	8	9	7				
				8				

FIGURA 111: CARCASA DERECHA

COMPONENTES			ÍTEM	REFERENCIA	COD. SAP	DESCRIPCIÓN	CANTIDAD	
	1	2	3	1	4050258-002000	11075908	CARCASA DER SUBCONJUNTO	1
				2	1050858-003000	11072833	BOMBA DE ACEITE	1
				3	1051658-006000	11072892	EMPAQUE BOMBA DE ACEITE	1
	4	5	6	4	1050358-008000	11072998	PIÑÓN BOMBA DE ACEITE	1
				5	1250404-006000	11072984	PIN CILINDRICO D5X18	1
				6	1251512-007000	11072812	ARANDELA 12.2X20X1	1
	7	8	9	7	1251401-003000	11071830	GUÍA CARCASA D10 X 14	1
				8	1051458-002000	11073035	RETENEDOR D9.8XD15.2X2.7	1
				9	1251401-001000	11071829	GUÍA CARCASA D8 X 14	2
	1	2	3	1	1051354-012000	11072817	ARANDELA 9.2 X 18 X 1	1
	 <small>9.2x18x1</small>			2	1251112-002093	11071978	PERNO HEX M6 X 30	2
				3	1251112-003093	11071982	PERNO HEXAGONAL M6 X 45	3
	4	5	6	4	1251112-006093	11072975	PERNO HEX M6X90	1
				5				
				6				
				7				
				8				

FIGURA 112: CARCASA DERECHA

COMPONENTES			ÍTEM	REFERENCIA	COD. SAP	DESCRIPCIÓN	CANTIDAD	
	1	2	3	1	4050258-003000	11075909	CARCASA DERECHA COMPLETA	1
				2	1050158-004000	11072919	GUÍA CADENILLA	1
				3	1251100-168093	11072964	PERNO ALLEN M6X15-10X7.8	1
	4	5	6	4	1251512-001000	11072816	ARANDELA 6.2X15X1	2
				5	1050653-002000	11072929	LEVA DE CAMBIOS	1
				6	1050654-008000	11075407	RESORTE	1
	7	8	9	7	1251100-068093	11071832	PERNO M6X14-9X2.6	1
				8	1051353-006000	11075836	CUBIERTA	1
				9	1251112-001093	11071977	PERNO HEX CON BRIDA M6 X 16	2
	1	2	3	1	1050858-001000	11072908	FILTRO 75.7X53.2	1
				2	1050858-008000	11075917	TAPA CÁMARA DE GASES	1
				3	1051458-004000	11072891	EMPAQUE	1
	4	5	6	4	1251100-061093	11071976	PERNO HEX CON BRIDA M6 X 22	2
				5				
				6				
				7				
				8				

FIGURA 113: CARCASA DERECHA

		COMPONENTES	ÍTEM	REFERENCIA	COD. SAP	DESCRIPCIÓN	CANTIDAD		
	1	2	3	1	4050258-003000	11075909	CARCASA DERECHA COMPLETA	1	
				2	1050558-003000	11073044	RODAMIENTO BOLAS 63/22/P53	1	
				3	1250601-052000	11072619	RODAMIENTO BOLAS 62 / 22 / P5	1	
		4	5	6	4	1250601-057000	11073043	RODAMIENTO BOLAS 6203/P5	1
				5	1050658-005000	11073039	RODAMIENTO BOLAS 16004P63	1	
				6	1051371-003000	11073009	PLATINA RODAMIENTO	2	
		7	8	9	7	1251100-067093	11071833	PERNO M6X10	2
			10	8	1051353-014000	11072086	BUJE	1	
				9	1251111-005094	11075406	ESPARRAGO M10X1.25-M10X1.25X168	2	
				10	1050853-019000	11075838	TAPON DE ACEITE D5x7,5	3	

FIGURA 114: TAPA CÁRTER IZQ

		COMPONENTES	ÍTEM	REFERENCIA	COD. SAP	DESCRIPCIÓN	CANTIDAD	
	1	2	3	1	4050358-002051	11075913	SUBCONJUNTO TAPA CÁRTER IZQ	1
				2	1051653-004000	11072897	EMPAQUE CUBIERTA CARCASA IZQ	1
				3	4051058-001051	11075348	TAPA FILTRO DE ACEITE	1
	4	5	6	4	1051454-022000	11072952	O-RING 69X3	1
				5	4050956-003051	11072682	TAPÓN ROSCADOALUMINIO M30 X 1,5	1
				6	1051454-023000	11072947	O-RING 27.4X2.65	1
	7	8	9	7	1040953-002093	11071943	TAPÓN M14 X 1,5	1
				8	1051454-024000	11072941	O-RING 13X2.8	1
				9	1251112-002093	11071978	PERNO HEX M6 X 30	4
	10	11	12	10	1251112-005093	11072244	PERNO CON BRIDA M6 X 75	7
				11	1251401-001000	11071829	GUÍA CARCASA D8 X 14	2

FIGURA 115: CUBIERTA CARCASA MOTOR IZQUIERDA

	COMPONENTES			ÍTEM	REFERENCIA	COD. SAP	DESCRIPCIÓN	CANTIDAD
		1	2	3	1	4050358-003051	11072868	CUBIERTA CARCASA MOTOR IZQ
				2	1051058-001000	11073013	PLATO DE BOBINAS	1
				3	1051353-005000	11072587	PLATINA PLATO BOBINAS	1
4		5	6	4	1251201-001094	11072089	TORNILLO CILÍNDRI HEXAG M5 X 15	3
				5	1251201-002094	11072090	TORNILLO CILÍNDRIC HEXAG M6 X 35	3
				6				
7		8	9	7				
				8				
				9				

FIGURA 116: TAPA PIÑÓN REDUCTOR ARRANQUE

	COMPONENTES			ÍTEM	REFERENCIA	COD. SAP	DESCRIPCIÓN	CANTIDAD
		1	2	3	1	4051058-002000	11075632	TAPA PIÑÓN REDUCTO ARRANQUE
				2	1250601-035000	11073042	RODAMIENTO BOLAS 6201RS/P6	1
				3	1051358-008000	11072989	PIN DE SEGURIDAD D32X1.2	1
4		5	6	4				
				5				
				6				
7		8	9	7				
				8				
				9				

FIGURA 117: TAPA CARTER DERECHA







	COMPONENTES			ÍTEM	REFERENCIA	COD. SAP	DESCRIPCIÓN	CANTIDAD
					1	4050458-012051	11075922	SUBCONJUNTO TAPA CÁRTER DER
				2	1051658-008000	11072898	EMPAQUE CUBIERTA DERECHA	1
				3	1051354-009000	11072928	LEVA CABLE CLUTCH	2
				4	1050754-018000	11075421	RESORTE LEVA CLUTCH	1
				5	1050854-007000	11072986	PIN D6X6	2
				6	1251401-001000	11071829	GUÍA CARCASA D8 X 14	2
				7	1251112-003093	11071982	PERNO HEXAGONAL M6 X 45	6
				8	1251112-004093	11071831	PERNOS CON BRIDA M6 X 60	3
				9	1251112-005093	11072244	PERNO CON BRIDA M6 X 75	1
		 6.3X12X1.6		1	1251112-006093	11072975	PERNO HEX M6X90	1
				2	1251513-001019	11071896	ARANDELA DE COBRE 6.3X12X1.6	1
				3	1051154-004000	11072810	ARANDELA 10.2X18X1	1
				4	1051154-003000	11072071	PIN DE SEGURIDAD D10	1
				5				
				6				
				7				
				8				

FIGURA 118: TAPA CARTER DERECHA

COMPONENTES			ÍTEM	REFERENCIA	COD. SAP	DESCRIPCIÓN	CANTIDAD	
	1	2	3	1	4050458-011051	11075923	SUBCONJUNTO CÁRTER DERECHO	1
				2	4050454-015051	11075424	CUBIERTA BOMBA DE AGUA	1
				3	4050454-014051	11075423	CUBIERTA FILTRO DE ACEITE	1
				4	1051161-012000	11073069	TAPÓN LLENADO DE ACEITE	1
	4	5	6	5	1051461-007000	11072946	O-RING 25X3.1	1
				6	1251300-096000	11073079	TUERCA CIEGA M6X13	3
				7	1050254-008000	11072886	EJE DE CLUTCH	1
	7	8	9	8	1250511-003000	11072992	PIN DE SEGURIDAD D9	1
				9	1051154-004000	11072810	ARANDELA 10.2X18X1	1
	1	2	3	1	4134300-001000	11072909	FILTRO DE ACEITE	1
				2	1051454-005000	11075404	RETENEDOR FILTRO DE ACEITE	1
				3	1050853-009000	11073023	RESORTE FILTRO D16.4X17X1.6	1
				4	1051454-020000	11072950	O-RING 55X2.5	1
	4	5	6	5	1051454-006000	11072893	EMPAQUE BOMBA DE AGUA	1
				6	1251401-001000	11071829	GUÍA CARCASA D8 X 14	2
				7	1251100-067093	11071833	PERNO M6X10	1
	7	8	9	8	1251112-002093	11071978	PERNO HEX M6 X 30	3
				9	1251513-001019	11071896	ARANDELA DE COBRE 6.3X12X1.6	1
1	2	3	1	1051458-001000	11072951	O-RING 6.5X2	2	
			2	1051358-001000	11072825	ARANDELA DE COBRE	2	
			3	1251100-317000	11072976	PERNO HEX M7X12.5	2	
			4	1051358-007000	11075369	ARANDELA VÁLVULA	1	
4	5	6	5	1050858-006000	11075370	RESORTE VÁLVULA	1	
			6	1050858-007000	11075915	ÉMBOLO VÁLV ALIVIO DE PRESIÓN	1	
			7	1051358-006000	11072987	PIN DE SEGURIDAD D15	1	
7	8	9	8	1051761-005000	11075371	CONDUCTO D3XD5X23	1	
			9	1051958-003000	11075372	MANGUERA	1	

FIGURA 119: CUBIERTA CARCASA MOTOR DERECHA

COMPONENTES			ÍTEM	REFERENCIA	COD. SAP	DESCRIPCIÓN	CANTIDAD	
	1	2	3	1	4050458-007051	11072867	CUBIERTA CARCASA MOTOR DER	1
				2	1250602-033000	11071955	RODAMIENTO DE AGUJAS HK 1412	1
				3	1250602-022000	11071954	RODAMIENTO DE AGUJAS HK 1010	1
				4	1051554-004000	11073027	RETENEDOR 12X23X7	1
	4	5	6	5	1051570-007000	11073029	RETENEDOR 12X24X5	1
				6	1051554-001000	11073028	RETENEDOR 12X24X5	1
				7	1051553-002000	11071944	RETÉN 14 X 22 X 5	1
	7	8	9	8	1051361-002000	11072988	PIN DE SEGURIDAD D30X1.2	1
				9	1050861-002000	11073089	VISOR NIVEL ACEITE	1
				1	1251111-013000	11072904	ESPARRAGO M6X25.5	3
				2	1051354-013000	11072091	PIN DE SEGURIDAD D24 X 1	1
				3	1250601-077000	11073041	RODAMIENTO BOLAS 6201-C	1
				4	1251512-045000	11072819	ARANDELA D12.8XD23X1	1
	4	5	6	5	1051958-002000	11072884	EJE BOMBA DE AGUA	1
				6	1051958-001000	11073050	ROTOR COMBA DE AGUA	1
				7	1251512-007000	11072812	ARANDELA 12.2X20X1	1
				8	1250404-006000	11072984	PIN CILINDRICO D5X18	1
	7	8	9	9	1051954-006000	11074398	RETENEDOR BOMBA DE AGUA	1
				1	1051454-008000	11072942	O-RING 19X1.5	1
				2	1050358-006000	11073000	PIÑÓN BOMBA DE AGUA	1
				3	1051954-007000	11075684	CONDUCTO	1
				4				
	4	5	6	5				
				6				
				7				
				8				
	7	8	9	9				

FIGURA 120: MOTOR DE ARRANQUE

COMPONENTES			ÍTEM	REFERENCIA	COD. SAP	DESCRIPCIÓN	CANTIDAD	
	1	2	3	1	1051058-004000	11072939	MOTOR DE ARRANQUE	1
				2	4051658-010000	11073003	PIÑÓN REDUCTOR	1
				3	1251512-007000	11072812	ARANDELA 12.2X20X1	2
	4	5	6	4	1050358-001000	11072996	PIÑÓN ARRANQUE	1
				5	1251512-004000	11072811	ARANDELA 10.2X21X1	2
				6	1051058-002000	11073090	VOLANTE	1
	7	8	9	7	1051058-008000	11072997	PIÑÓN ARRANQUE ELÉCTRICO	1
				8	1051358-005000	11072821	ARANDELA D28.2XD40X1	2
				9	1051058-009000	11073049	RODAMIENTO DE AGUJAS D28XD34X22	1
	1	2	3	1	1051354-006000	11072815	ARANDELA 30.2X41.2X1.5	1
				2	1251500-034000	11072374	ARANDELA 12,3 X 26 X 3	1
				3	1251100-065094	11072972	PERNO HEX M12X1.25X50	1
	4	5	6	4	1251112-002093	11071978	PERNO HEX M6 X 30	2
				5				
				6				
				7				
				8				

FIGURA 121: CADENILLA DE DISTRIBUCIÓN

	COMPONENTES			ÍTEM	REFERENCIA	COD. SAP	DESCRIPCIÓN	CANTIDAD
		1	2	3	1	1051261-001000	11072849	CADENILLA 6.35X9X132
				2	1050158-004000	11072919	GUÍA CADENILLA	1
				3	1050158-005000	11072918	GUÍA CADENILLA	1
4		5	6	4	1251100-168093	11072964	PERNO ALLEN M6X15-10X7.8	1
				5	1251512-001000	11072816	ARANDELA 6.2X15X1	1
				6	1050154-034000	11073012	PLATINA TAPA CULATA	1
7		8	9	7	1051253-003000	11073070	TENSOR CADENILLA	1
				8	1051253-004000	11072605	RETENEDOR 30 X 38	1
				9	1251100-067093	11071833	PERNO M6X10	1
1		2	3	1	1251513-001019	11071896	ARANDELA DE COBRE 6.3X12X1.6	1
				2	1251112-002093	11071978	PERNO HEX M6 X 30	2
				3				
4		5	6	4				
				5				
				6				
7		8	9	7				
				8				
				9				